

MHI

SERVICE MANUAL

Manual No. '09 • SRK/SRF - SM - 082
updated 25,May,2009

INVERTER WALL MOUNTED TYPE AND FLOOR STANDING TYPE ROOM AIR-CONDITIONER (Split system, air to air heat pump type)

Wall mounted type Floor standing type

SRK20ZIX-S

SRF25ZIX-S

25ZIX-S

35ZIX-S

35ZIX-S

50ZIX-S

50ZIX-S

60ZIX-S



MITSUBISHI HEAVY INDUSTRIES, LTD.



Большая библиотека технической документации
<http://splitoff.ru/tehn-doc.html>
каталоги, инструкции, сервисные мануалы, схемы.

TABLE OF CONTENTS

1. WALL MOUNTED TYPE(SRK)	2
2. FLOOR STANDING TYPE(SRF)	45
3. MAINTENANCE DATA	69
3.1 Troubleshooting procedures for electrical equipment	69
3.2 Servicing	90
4. REFRIGERANT PIPING INSTALLATION / SERVICING MANUAL	
FOR AIR CONDITIONERS USING R410A	91
4.1 Outline	91
4.2 Refrigerant piping installation	92
4.3 Installation, removal and servicing	98
4.4 Refrigerant recovery	103

1. WALL MOUNTED TYPE(SRK)

CONTENTS

1.1 Electrical wiring	3
1.2 Piping system	6
1.3 Noise level	7
1.4 Sensible heat capacity	12
1.5 Application data	14
1.5.1 Installation of indoor unit	14
1.5.2 Installation of outdoor unit	18
1.6 Outline of operation control by microcomputer	33

■ How to read the model name

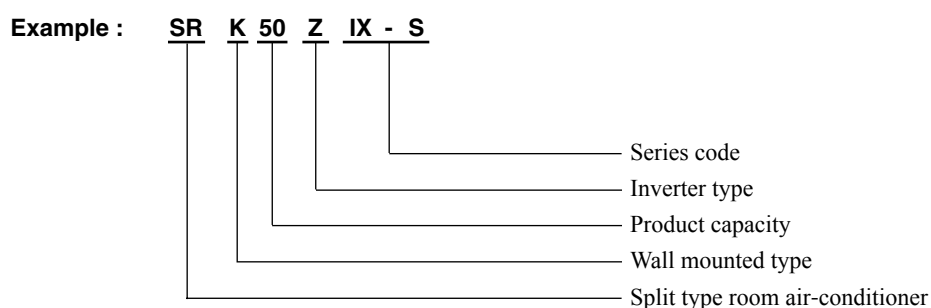

1.1 Electrical wiring

(1) Indoor unit

Models SRK20ZIX-S, 25ZIX-S, 35ZIX-S, 50ZIX-S, 60ZIX-S

Всe каталоги и инструкции здесь: <http://splitoff.ru/ehh-doc.html>

Item	Description
CNE-CNY	Connector
FM ₁	Fan motor
SM _{1,2}	Flap motor
LM _{1,2}	Louver motor
IM	Inlet motor
Th1	Room temp. sensor
Th2 _{1,2}	Heat exch. sensor
Th3	Humidity sensor (50, 60 on
LS	Limit switch
DS	Diode stack
F	Fuse
T	Terminal block
Va	Varistor

Color Marks

Mark	Color
BK	Black
BL	Blue
RD	Red
WH	White
Y	Yellow
Y/G	Yellow/Green

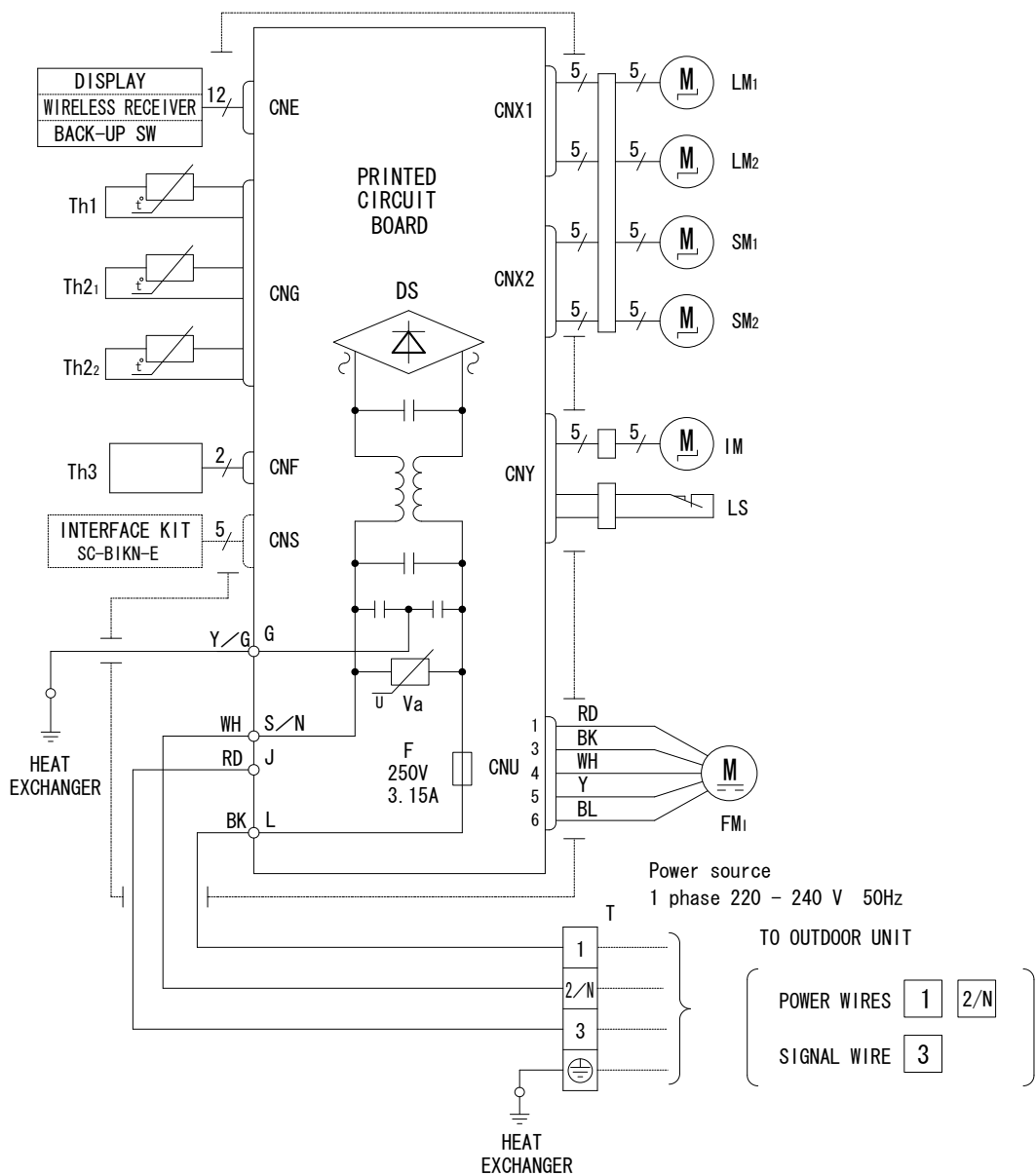

RWA000Z215

(2) Outdoor unit
 Models SRC20Z1X-S, 25Z1X-S, 35Z1X-S

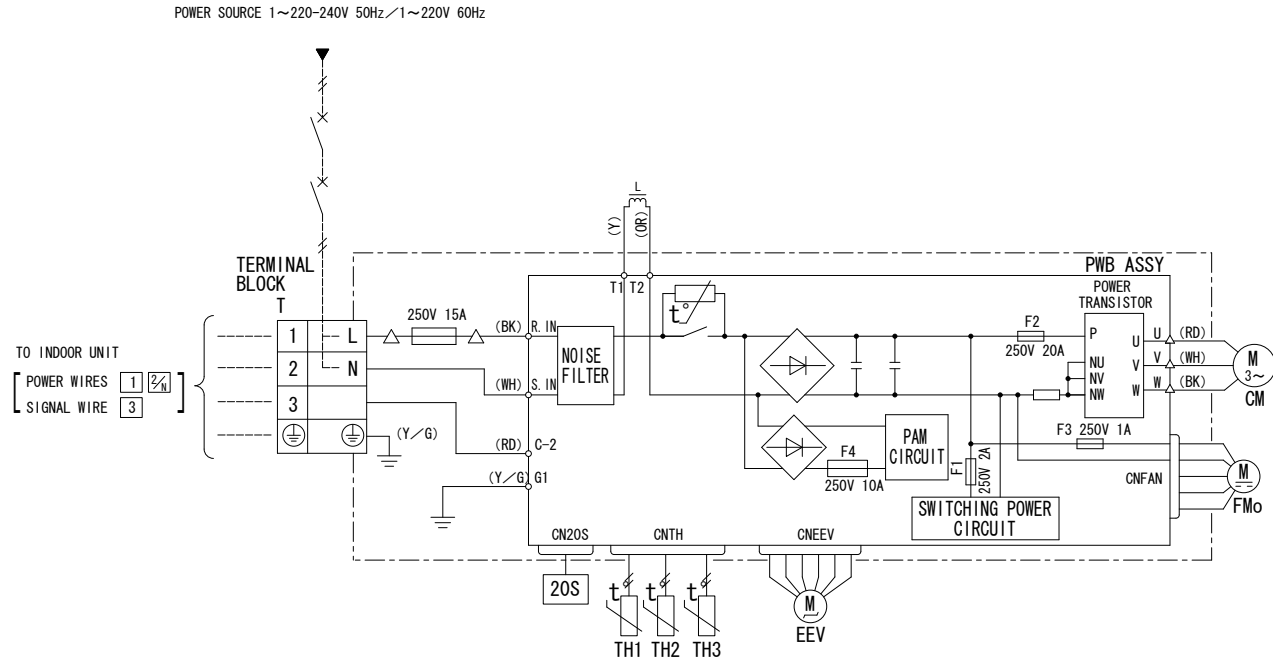

Item	Description
CM	Compressor motor
CNEEV~20S	Connector
EEV	Electric expansion valve (coil)
FMO	Fan motor
L	Reactor
T	Terminal block
TH1	Heat exchanger sensor (outdoor unit)
TH2	Outdoor air temp. sensor
TH3	Discharge pipe temp. sensor
20S	Solenoid valve for 4 way valve

Mark	Color
BK	Black
OR	Orange
RD	Red
WH	White
Y	Yellow
Y/G	Yellow/Green

Power cable, indoor-outdoor connecting wires

Model	MAX running current (A)	Power cable size (mm ²)	Power cable length (m)	indoor-outdoor wire size x number	Earth wire size (mm)
20	8	2.0	32	φ1.6mm x 3	φ1.6mm
25					
35					

- The specifications shown in the above table are for units without heaters. For units with heaters, refer to the installation instructions or the construction instructions of the indoor unit.
- Switchgear of Circuit breaker capacity which is calculated from MAX. over current should be chosen along the regulations in each country.
- The cable specifications are based on the assumption that a metal or plastic conduit is used with no more than three cables contained in a conduit and a voltage drop is 2%. For an installation falling outside of these conditions, please follow the internal cabling regulations. Adapt it to the regulation in effect in each country.

RWSC000Z213

POWER SOURCE 1~220-240V 50Hz/1~220V 60Hz

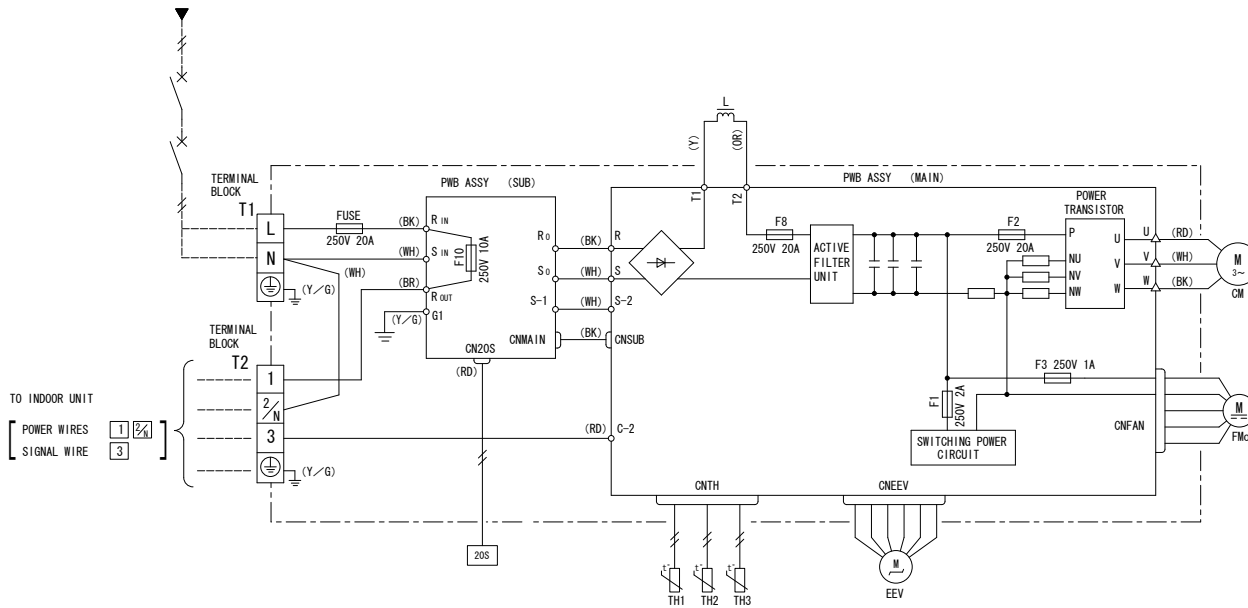

Item	Description
CM	Compressor motor
CNEEV~20S	Connector
EEV	Electric expansion valve
FMo	Fan motor
L	Reactor
T1,2	Terminal block
TH1	Heat exchanger sensor (unit)
TH2	Outdoor air temp. sensor
TH3	Discharge pipe temp. sensor
20S	Solenoid valve for 4-way

Mark	Color
BK	Black
BR	Brown
OR	Orange
RD	Red
WH	White
Y	Yellow
Y/G	Yellow/Green

Power cable, indoor-outdoor connecting wires

Model	MAX running current (A)	Power cable size (mm ²)	Power cable length (m)	indoor-outdoor wire size x number	Earth wire size (mm)
50	14	2.0	18	φ1.6mm x 3	φ1.6mm
60					

- The specifications shown in the above table are for units without heaters. For units with heaters, refer to the installation instructions or the construction instructions of the indoor unit.
- Switchgear of Circuit breaker capacity which is calculated from MAX. over current should be chosen along the regulations in each country.
- The cable specifications are based on the assumption that a metal or plastic conduit is used with no more than three cables contained in a conduit and a voltage drop is 2%. For an installation falling outside of these conditions, please follow the internal cabling regulations. Adapt it to the regulation in effect in each country.

RWC000Z214

1.2 Piping system

Model SRK20ZIX-S, 25ZIX-S, 35ZIX-S

Все каталоги и инструкции здесь: <http://splitoff.ru/tehn-doc.html>

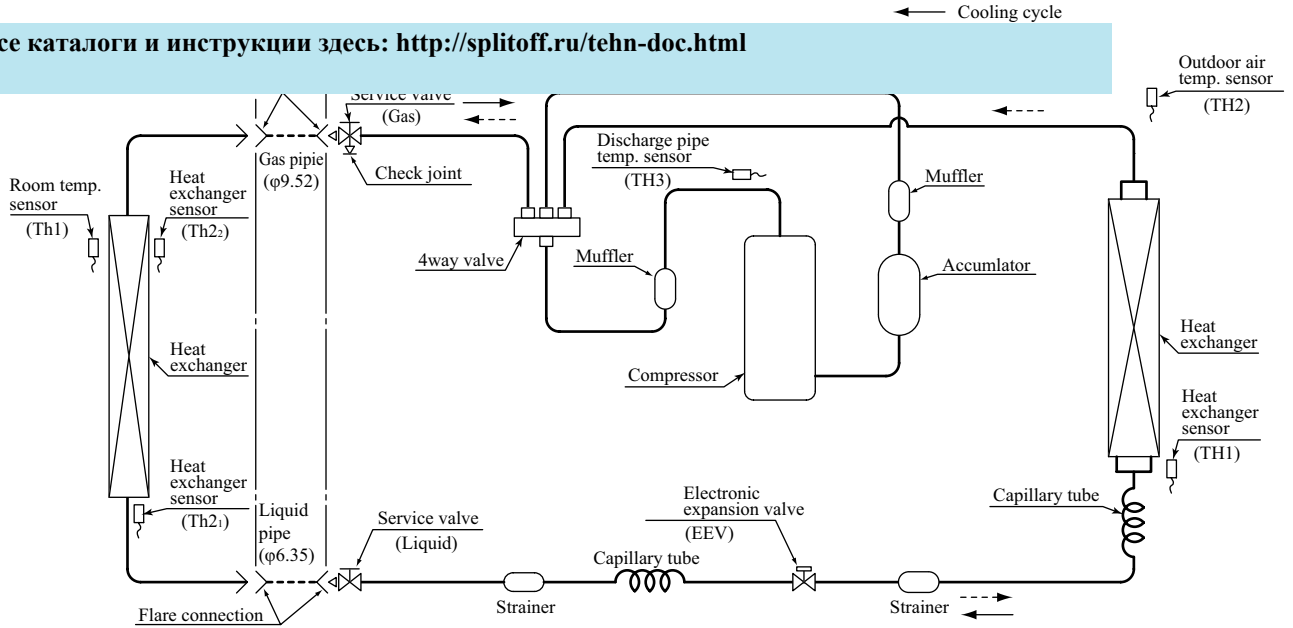

Model SRK50ZIX-S, 60ZIX-S

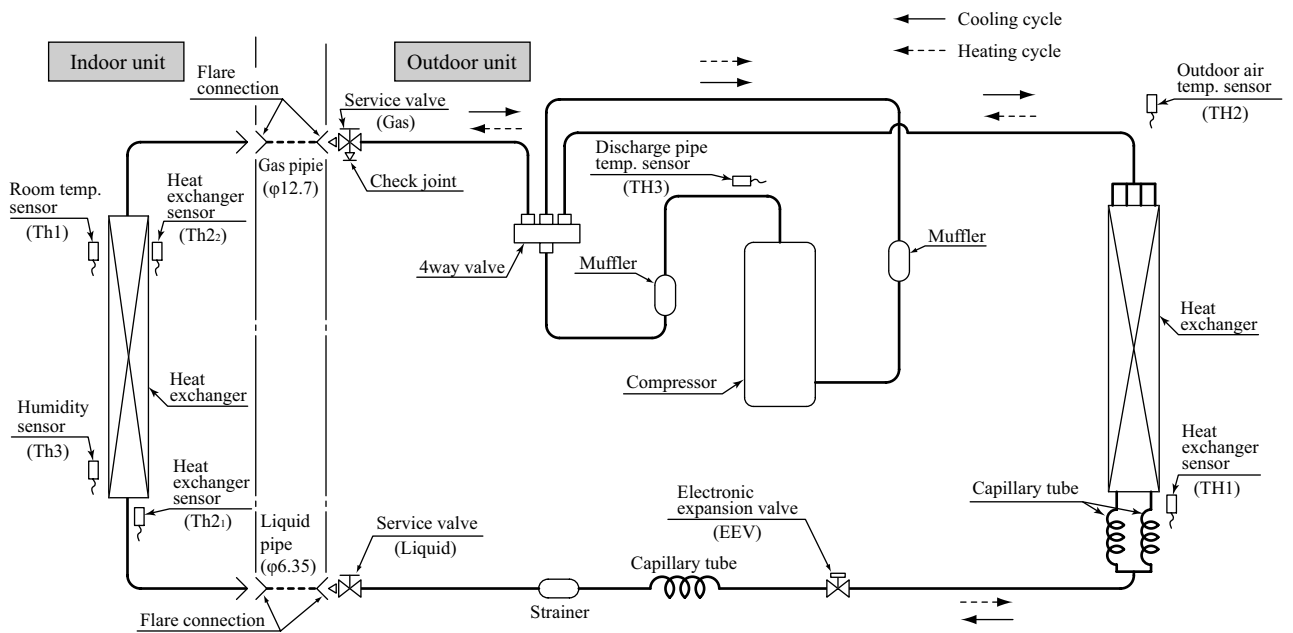

1.3 Noise level

Model SRK20ZIX-S

Condition	ISO-T1, JIS C9612
-----------	-------------------

(Indoor Unit)

Все каталоги и инструкции здесь: <http://splitoff.ru/tehn-doc.html>

Noise Level	Cooling	39 dB(A)
	Heating	38 dB(A)

× Cooling, ○ — Heating

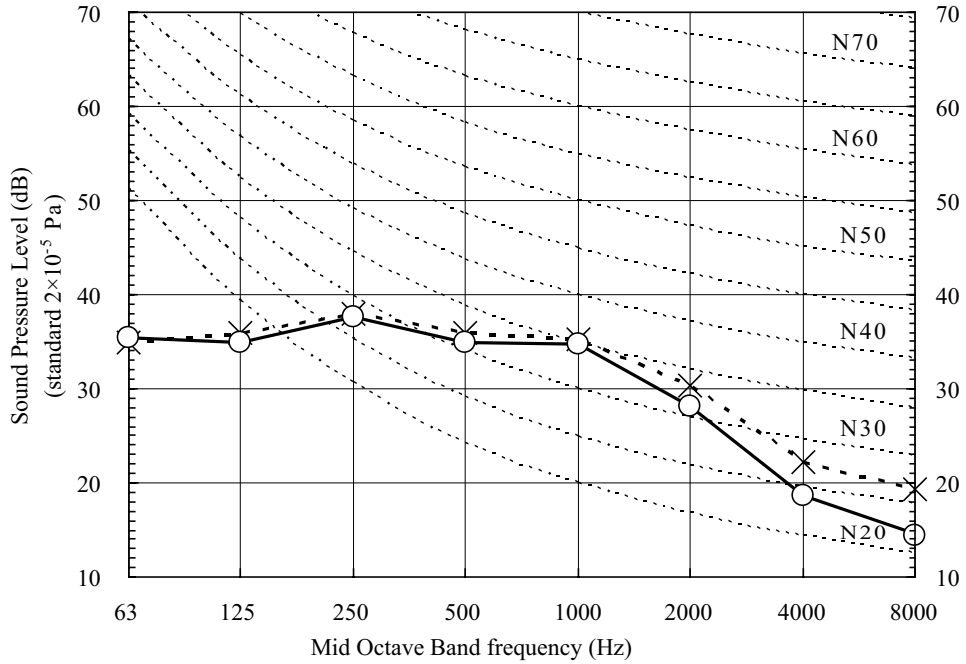

(Outdoor Unit)

Model	SRC20ZIX-S	
Noise Level	Cooling	47 dB(A)
	Heating	47 dB(A)

× Cooling, ○ — Heating

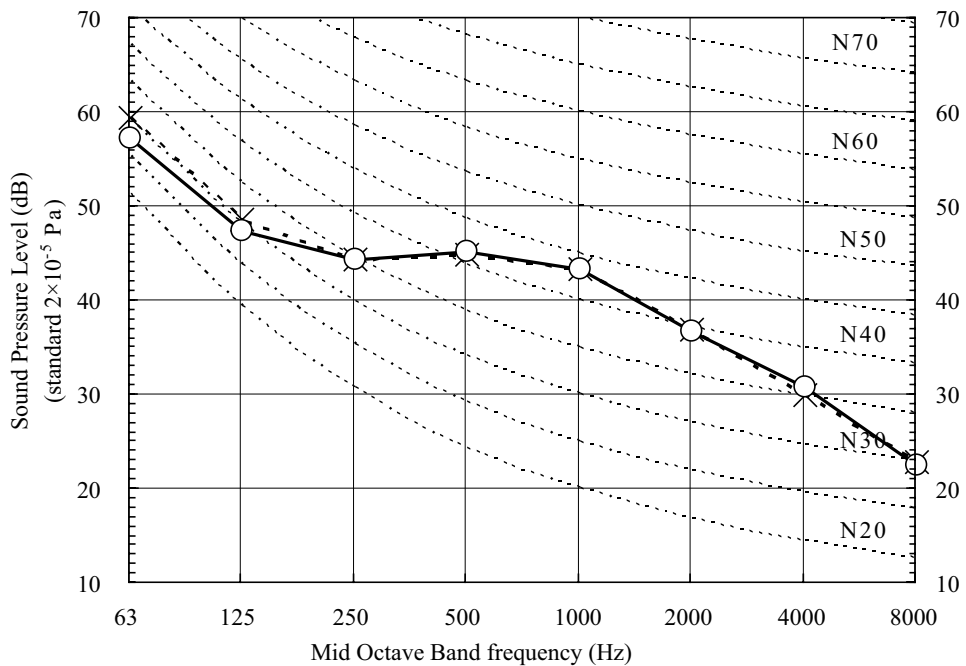

Model SRK25ZIX-S

Condition ISO-T1,JIS C9612

(Indoor Unit)

Model	SRK25ZIX-S	
Noise Level	Cooling	41 dB(A)

Все каталоги и инструкции здесь: <http://splitoff.ru/tehn-doc.html>

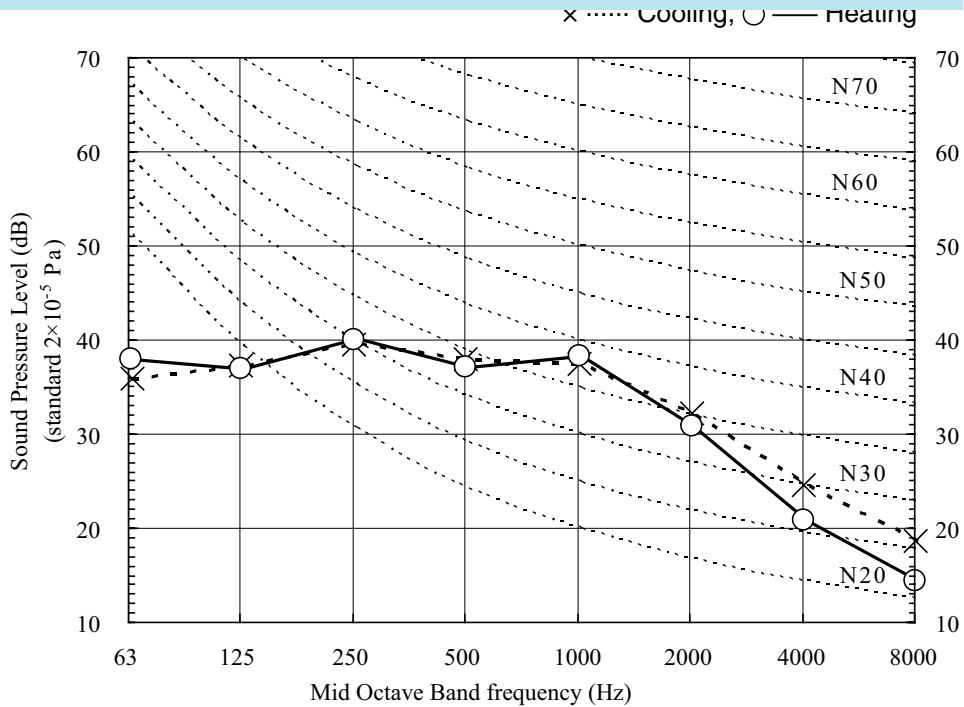

(Outdoor Unit)

Model	SRC25ZIX-S	
Noise Level	Cooling	47 dB(A)
	Heating	47 dB(A)

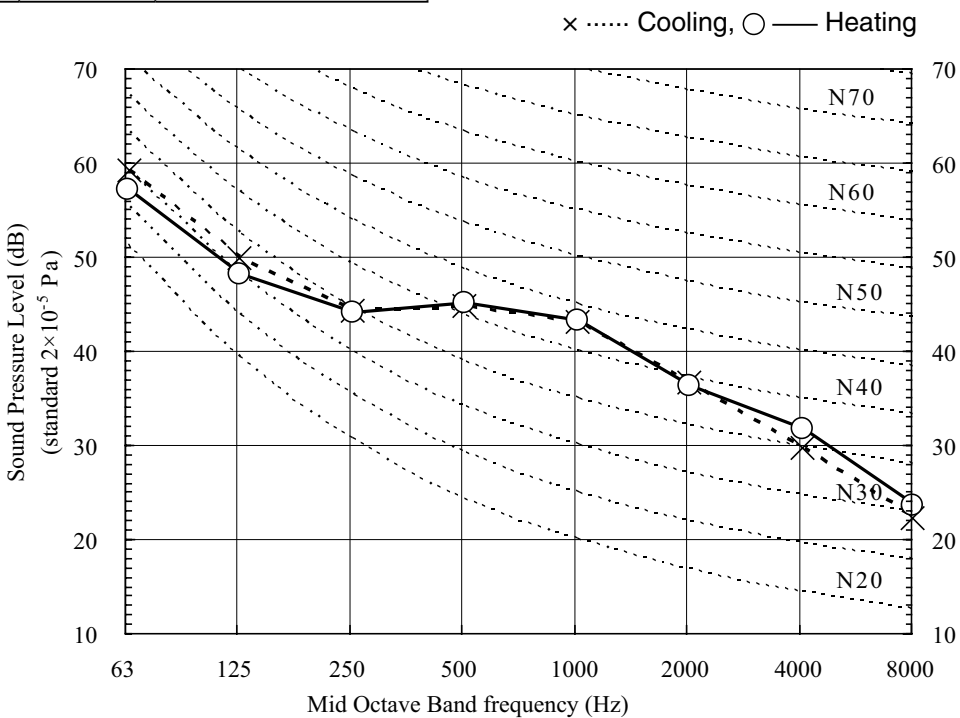

Model SRK35ZIX-S

Condition ISO-T1,JIS C9612

(Indoor Unit)

Model	SRK35ZIX-S	
Noise Level	Cooling	42 dB(A)

Все каталоги и инструкции здесь: <http://splitoff.ru/tehn-doc.html>

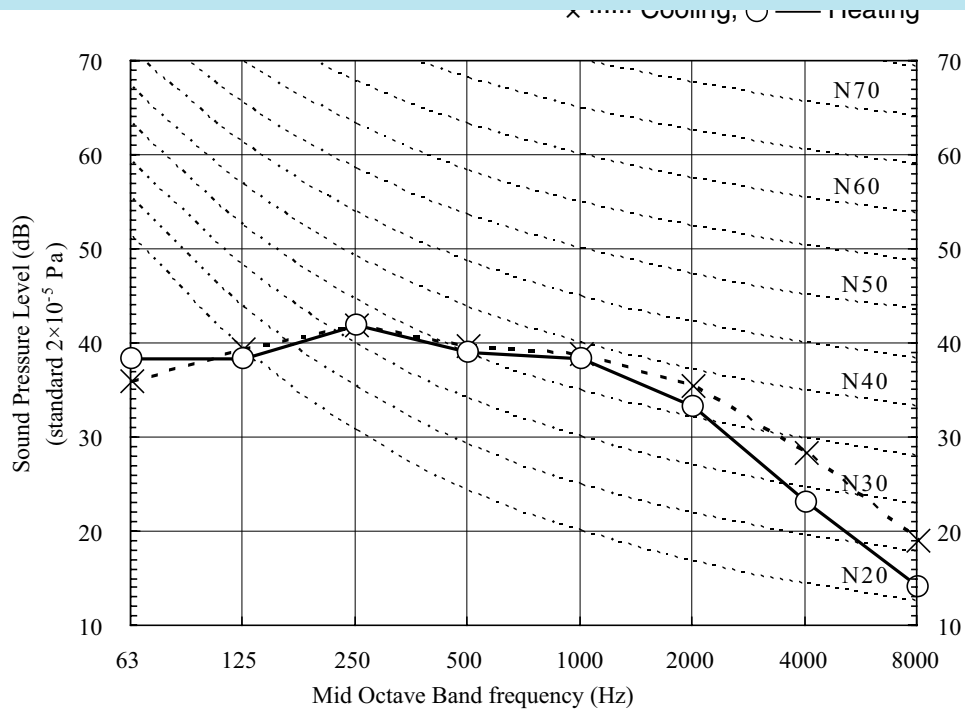

(Outdoor Unit)

Model	SRC35ZIX-S	
Noise Level	Cooling	50 dB(A)
	Heating	50 dB(A)

× Cooling, ○ — Heating

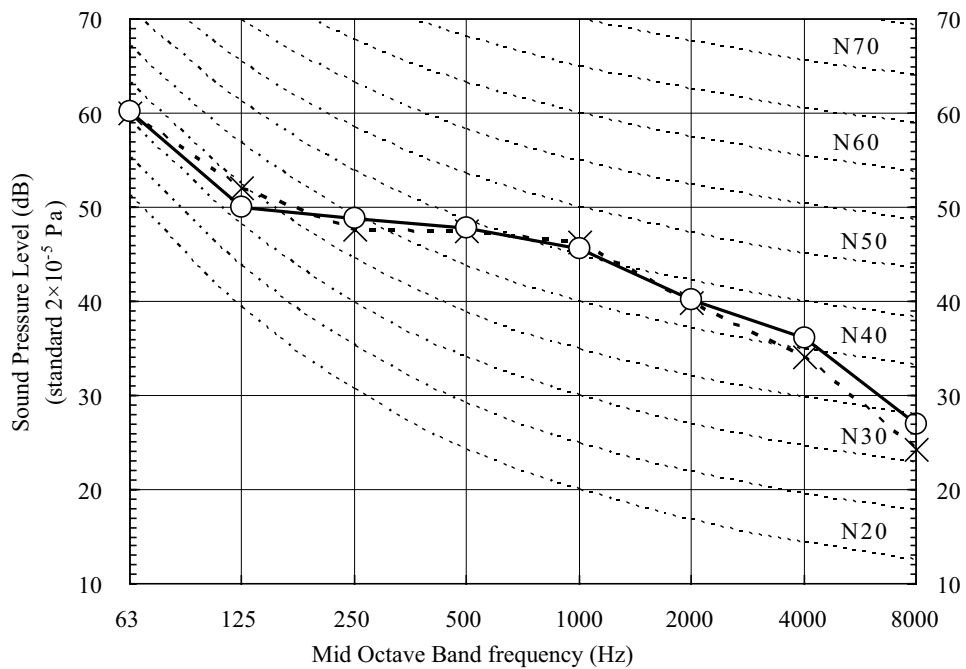

Model SRK50ZIX-S

Condition ISO-T1, JIS C9612

(Indoor Unit)

Model	SRK50ZIX-S	
Noise Level	Cooling	45 dB(A)

Все каталоги и инструкции здесь: <http://splitoff.ru/tehn-doc.html>

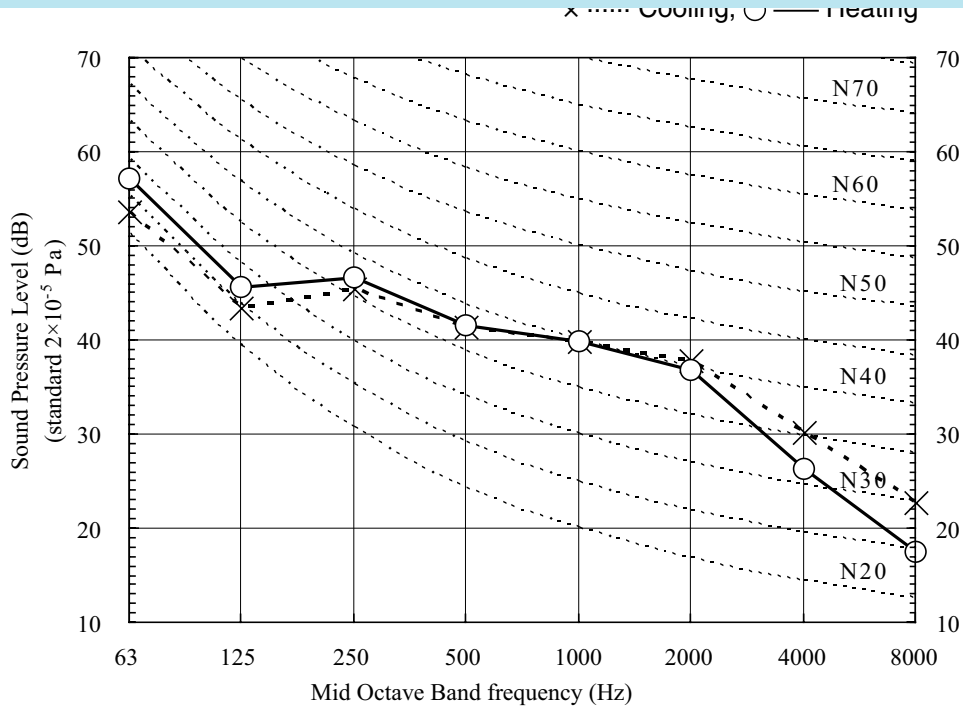

(Outdoor Unit)

Model	SRC50ZIX-S	
Noise Level	Cooling	48 dB(A)
	Heating	48 dB(A)

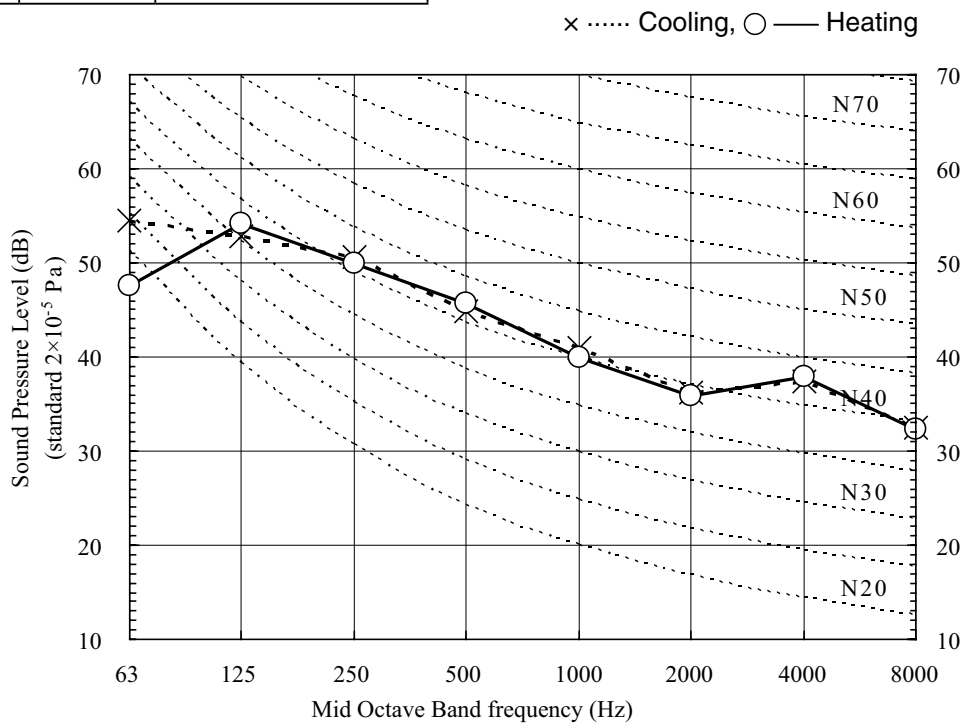

Model SRK60ZIX-S

Condition	ISO-T1,JIS C9612
-----------	------------------

(Indoor Unit)

Model	SRK60ZIX-S	
Noise Level	Cooling	47 dB(A)

Все каталоги и инструкции здесь: <http://splitoff.ru/tehn-doc.html>

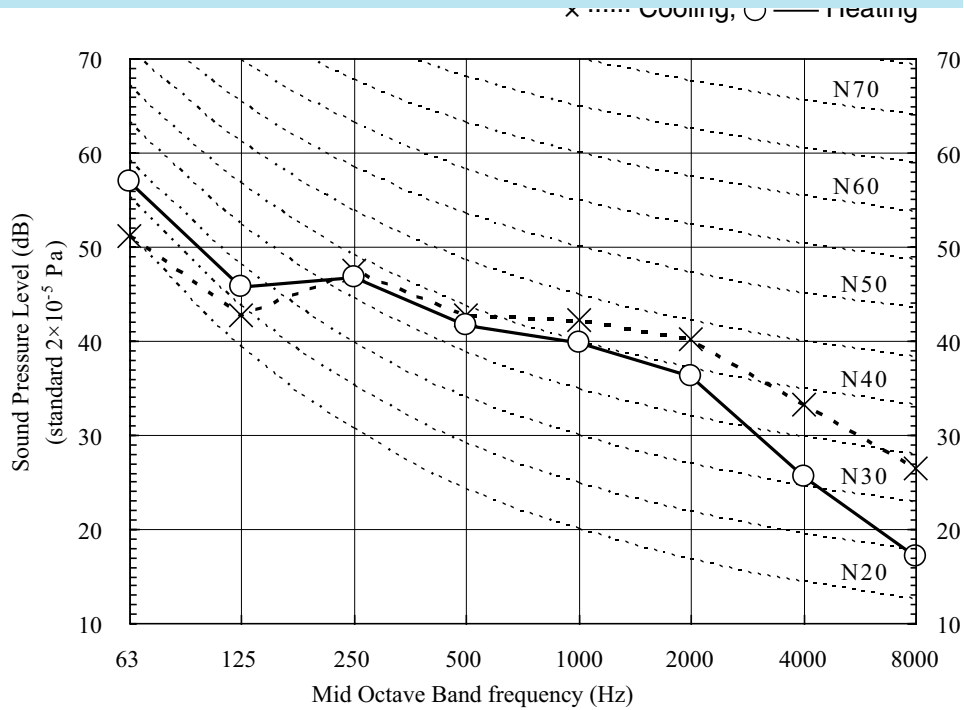

(Outdoor Unit)

Model	SRC60ZIX-S	
Noise Level	Cooling	51 dB(A)
	Heating	51 dB(A)

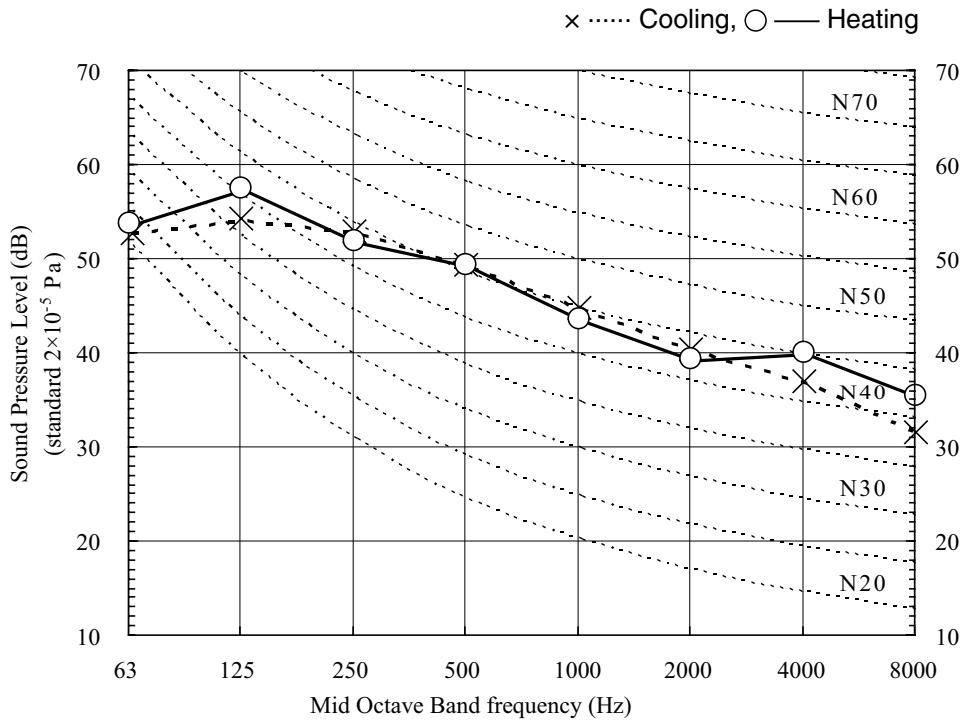

1.4 Sensible heat capacity

Model SRK20ZIX-S

Cool Mode

Air flow	Outdoor air temp.	Indoor air temp													
		21°CDB 14°CWB		23°CDB 16°CWB		26°CDB 18°CWB		27°CDB 19°CWB		28°CDB 20°CWB		31°CDB 22°CWB		33°CDB 24°CWB	
		TC	SHC	TC	SHC	TC	SHC	TC	SHC	TC	SHC	TC	SHC	TC	SHC
Hi 11.5 (m³/min)	12	2.21	2.12	2.32	2.09	2.41	2.22	2.45	2.20	2.50	2.18	2.58	2.29	2.65	2.24
	14	2.17	2.10	2.28	2.07	2.38	2.21	2.42	2.19	2.47	2.17	2.55	2.28	2.62	2.23
	16	2.13	2.08	2.24	2.05	2.34	2.19	2.39	2.18	2.43	2.15	2.52	2.27	2.59	2.22
	18	2.08	2.06	2.19	2.03	2.30	2.17	2.35	2.16	2.40	2.14	2.49	2.26	2.56	2.21
	20	2.04	2.04	2.15	2.02	2.26	2.16	2.31	2.15	2.36	2.13	2.45	2.25	2.53	2.20
	22	1.99	1.99	2.10	2.00	2.22	2.15	2.28	2.13	2.32	2.12	2.42	2.23	2.50	2.19
	24	1.94	1.94	2.05	1.98	2.18	2.13	2.24	2.11	2.28	2.10	2.38	2.23	2.47	2.18
	26	1.90	1.90	2.01	1.97	2.14	2.11	2.20	2.10	2.24	2.08	2.35	2.21	2.43	2.18
	28	1.85	1.85	1.96	1.94	2.09	2.09	2.15	2.09	2.20	2.05	2.31	2.20	2.40	2.16
	30	1.79	1.79	1.90	1.90	2.05	2.05	2.11	2.05	2.16	2.04	2.27	2.19	2.36	2.15
	32	1.74	1.74	1.85	1.85	2.00	2.00	2.07	2.04	2.12	2.02	2.23	2.18	2.32	2.14
	34	1.69	1.69	1.80	1.80	1.95	1.95	2.02	2.02	2.07	2.01	2.19	2.16	2.28	2.13
	35	1.66	1.66	1.77	1.77	1.93	1.93	2.00	2.00	2.05	2.01	2.17	2.16	2.26	2.12
	36	1.63	1.63	1.74	1.74	1.90	1.90	1.98	1.98	2.02	2.00	2.15	2.15	2.24	2.11
	38	1.58	1.58	1.68	1.68	1.85	1.85	1.93	1.93	1.98	1.98	2.11	2.11	2.20	2.10
	39	1.55	1.55	1.66	1.66	1.83	1.83	1.91	1.91	1.95	1.95	2.08	2.08	2.18	2.10

Heat Mode

Air flow	outdoor air temp.	indoor air temp				
		16°CDB	18°CDB	20°CDB	22°CDB	24°CDB
Hi 12.0 (m³/min)	-5°CWB	1.89	1.86	1.82	1.80	1.77
	0°CWB	1.98	1.95	1.91	1.89	1.86
	5°CWB	2.52	2.49	2.48	2.43	2.39
	6°CWB	2.56	2.53	2.50	2.47	2.44
	10°CWB	2.72	2.69	2.68	2.64	2.61
	15°CWB	2.96	2.93	2.91	2.88	2.85
	20°CWB	3.18	3.15	3.14	3.10	3.08

Все каталоги и инструкции здесь: <http://splitoff.ru/tehn-doc.html>

Model SRK25ZIX-S

Cool Mode

Air flow	Outdoor air temp.	Indoor air temp													
		21°CDB 14°CWB		23°CDB 16°CWB		26°CDB 18°CWB		27°CDB 19°CWB		28°CDB 20°CWB		31°CDB 22°CWB		33°CDB 24°CWB	
		TC	SHC	TC	SHC	TC	SHC	TC	SHC	TC	SHC	TC	SHC	TC	SHC
Hi 12.5 (m³/min)	10	2.87	2.69	3.01	2.65	3.12	2.80	3.17	2.77	3.23	2.74	3.32	2.88	3.41	2.81
	12	2.82	2.67	2.96	2.63	3.07	2.78	3.13	2.75	3.19	2.73	3.28	2.86	3.38	2.80
	14	2.77	2.64	2.90	2.61	3.03	2.76	3.09	2.74	3.14	2.69	3.25	2.85	3.34	2.79
	16	2.71	2.61	2.85	2.58	2.98	2.74	3.04	2.70	3.10	2.68	3.21	2.84	3.31	2.78
	18	2.66	2.59	2.80	2.56	2.93	2.71	3.00	2.69	3.05	2.66	3.17	2.82	3.27	2.77
	20	2.60	2.56	2.74	2.54	2.88	2.69	2.95	2.67	3.01	2.65	3.13	2.81	3.23	2.75
	22	2.54	2.54	2.68	2.51	2.83	2.67	2.90	2.65	2.96	2.63	3.08	2.80	3.19	2.74
	24	2.48	2.48	2.62	2.48	2.78	2.65	2.85	2.64	2.91	2.61	3.04	2.78	3.15	2.72
	26	2.42	2.42	2.56	2.46	2.72	2.63	2.80	2.62	2.86	2.60	2.99	2.76	3.10	2.71
	28	2.35	2.35	2.49	2.43	2.67	2.62	2.75	2.60	2.81	2.58	2.95	2.75	3.06	2.70
	30	2.29	2.29	2.43	2.40	2.61	2.59	2.69	2.58	2.75	2.56	2.90	2.74	3.01	2.69
	32	2.22	2.22	2.36	2.36	2.55	2.55	2.64	2.56	2.70	2.54	2.85	2.71	2.96	2.67
	34	2.15	2.15	2.29	2.29	2.49	2.49	2.58	2.55	2.64	2.53	2.79	2.70	2.91	2.65
	35	2.12	2.12	2.26	2.26	2.46	2.46	2.55	2.53	2.61	2.52	2.77	2.69	2.89	2.65
	36	2.08	2.08	2.22	2.22	2.43	2.43	2.52	2.52	2.58	2.51	2.74	2.68	2.86	2.64
	38	2.01	2.01	2.15	2.15	2.36	2.36	2.46	2.46	2.52	2.49	2.69	2.67	2.81	2.60
39	1.97	1.97	2.11	2.11	2.33	2.33	2.43	2.43	2.49	2.48	2.66	2.63	2.78	2.59	

Heat Mode

Air flow	outdoor air temp.	indoor air temp				
		16°CDB	18°CDB	20°CDB	22°CDB	24°CDB
Hi 13.0 (m³/min)	-15°CWB	1.93	1.88	1.84	1.80	1.76
	-10°CWB	2.18	2.14	2.11	2.06	2.02
	-5°CWB	2.36	2.33	2.28	2.25	2.22
	0°CWB	2.47	2.44	2.40	2.37	2.33
	5°CWB	3.15	3.12	3.10	3.04	2.99
	6°CWB	3.20	3.17	3.13	3.09	3.05
	10°CWB	3.40	3.37	3.35	3.30	3.27
	15°CWB	3.70	3.67	3.65	3.61	3.57
20°CWB	3.98	3.95	3.93	3.88	3.85	

Model SRK35ZIX-S

Cool Mode

Air flow	Outdoor air temp.	Indoor air temp													
		21°CDB 14°CWB		23°CDB 16°CWB		26°CDB 18°CWB		27°CDB 19°CWB		28°CDB 20°CWB		31°CDB 22°CWB		33°CDB 24°CWB	
		TC	SHC	TC	SHC	TC	SHC	TC	SHC	TC	SHC	TC	SHC	TC	SHC
Hi 13.5 (m³/min)	10	3.94	3.47	4.13	3.42	4.28	3.59	4.35	3.55	4.43	3.51	4.56	3.66	4.68	3.55
	12	3.87	3.44	4.06	3.39	4.22	3.56	4.29	3.53	4.37	3.49	4.51	3.65	4.63	3.53
	14	3.80	3.40	3.99	3.36	4.16	3.54	4.24	3.50	4.31	3.47	4.46	3.61	4.59	3.52
	16	3.72	3.37	3.91	3.32	4.09	3.51	4.18	3.48	4.25	3.44	4.40	3.59	4.54	3.50
	18	3.65	3.33	3.84	3.29	4.03	3.48	4.11	3.45	4.19	3.42	4.35	3.57	4.49	3.49
	20	3.57	3.30	3.76	3.25	3.96	3.46	4.05	3.43	4.13	3.39	4.29	3.55	4.43	3.47
	22	3.49	3.26	3.68	3.22	3.89	3.43	3.98	3.40	4.06	3.37	4.23	3.53	4.38	3.45
	24	3.40	3.22	3.59	3.19	3.81	3.40	3.91	3.38	3.99	3.35	4.17	3.51	4.32	3.44
	26	3.32	3.18	3.51	3.14	3.74	3.37	3.84	3.35	3.92	3.32	4.11	3.49	4.26	3.42
	28	3.23	3.14	3.42	3.11	3.66	3.34	3.77	3.32	3.85	3.30	4.04	3.47	4.20	3.40
	30	3.14	3.10	3.33	3.07	3.58	3.31	3.70	3.29	3.78	3.26	3.98	3.45	4.13	3.38
	32	3.05	3.05	3.24	3.03	3.50	3.27	3.62	3.26	3.70	3.24	3.91	3.43	4.06	3.36
	34	2.95	2.95	3.14	3.00	3.41	3.24	3.54	3.23	3.62	3.21	3.84	3.40	4.00	3.34
	35	2.91	2.91	3.10	2.98	3.37	3.23	3.50	3.22	3.58	3.20	3.80	3.39	3.96	3.33
	36	2.86	2.86	3.05	2.96	3.33	3.21	3.46	3.20	3.54	3.18	3.76	3.38	3.92	3.32
	38	2.76	2.76	2.95	2.91	3.24	3.18	3.38	3.18	3.46	3.15	3.69	3.36	3.85	3.30
39	2.71	2.71	2.90	2.89	3.20	3.16	3.33	3.16	3.42	3.14	3.65	3.34	3.81	3.29	

Heat Mode

Air flow	outdoor air temp.	indoor air temp				
		16°CDB	18°CDB	20°CDB	22°CDB	24°CDB
Hi 14.0 (m³/min)	-15°CWB	2.65	2.59	2.53	2.48	2.42
	-10°CWB	2.99	2.94	2.90	2.83	2.77
	-5°CWB	3.24	3.20	3.13	3.10	3.05
	0°CWB	3.40	3.35	3.29	3.25	3.20
	5°CWB	4.33	4.28	4.26	4.17	4.11
	6°CWB	4.40	4.35	4.30	4.25	4.19
	10°CWB	4.68	4.63	4.60	4.54	4.49
	15°CWB	5.09	5.04	5.01	4.95	4.91
20°CWB	5.47	5.42	5.40	5.34	5.29	

Model SRK50ZIX-S

Cool Mode

Air flow	Outdoor	Indoor air temp													
		21°CDB		23°CDB		26°CDB		27°CDB		28°CDB		31°CDB		33°CDB	
Hi 13.5 (m³/min)	12	5.53	4.22	5.80	4.15	6.03	4.29	6.14	4.23	6.25	4.18	6.44	4.27	6.62	4.15
	14	5.43	4.17	5.70	4.10	5.94	4.25	6.05	4.20	6.16	4.14	6.37	4.25	6.55	4.12
	16	5.32	4.11	5.59	4.05	5.85	4.21	5.96	4.16	6.08	4.10	6.29	4.22	6.48	4.10
	18	5.21	4.05	5.48	3.99	5.75	4.16	5.88	4.12	5.99	4.07	6.21	4.19	6.41	4.08
	20	5.10	3.99	5.37	3.94	5.65	4.12	5.78	4.08	5.90	4.03	6.13	4.16	6.33	4.05
	22	4.98	3.93	5.25	3.89	5.55	4.07	5.69	4.04	5.80	3.99	6.05	4.13	6.25	4.02
	24	4.86	3.87	5.14	3.83	5.45	4.03	5.59	4.00	5.71	3.95	5.96	4.10	6.17	3.99
	26	4.74	3.81	5.01	3.77	5.34	3.98	5.49	3.95	5.61	3.91	5.87	4.07	6.08	3.97
	28	4.61	3.75	4.89	3.71	5.23	3.93	5.39	3.91	5.50	3.87	5.78	4.03	5.99	3.93
	30	4.49	3.68	4.76	3.65	5.11	3.88	5.28	3.86	5.40	3.82	5.68	3.99	5.90	3.90
	32	4.35	3.62	4.63	3.59	5.00	3.83	5.17	3.82	5.29	3.78	5.58	3.96	5.81	3.87
	34	4.22	3.55	4.49	3.53	4.88	3.78	5.06	3.78	5.18	3.74	5.48	3.92	5.71	3.83
	35	4.15	3.52	4.42	3.50	4.82	3.75	5.00	3.75	5.12	3.71	5.43	3.91	5.66	3.82
	36	4.08	3.48	4.35	3.45	4.76	3.73	4.94	3.72	5.06	3.69	5.37	3.88	5.61	3.80
	38	3.94	3.41	4.21	3.39	4.63	3.67	4.82	3.68	4.94	3.65	5.27	3.85	5.50	3.77
	39	3.87	3.38	4.14	3.36	4.57	3.65	4.76	3.65	4.88	3.62	5.21	3.83	5.45	3.75

Heat Mode

Air flow	outdoor air temp.	indoor air temp				
		16°CDB	18°CDB	20°CDB	22°CDB	24°CDB
Hi 16.5 (m³/min)	-5°CWB	4.52	4.46	4.37	4.32	4.25
	0°CWB	4.74	4.67	4.59	4.54	4.47
	5°CWB	6.04	5.97	5.94	5.82	5.74
	6°CWB	6.14	6.07	6.00	5.92	5.85
	10°CWB	6.52	6.46	6.42	6.34	6.27
	15°CWB	7.10	7.04	6.99	6.91	6.85
	20°CWB	7.63	7.57	7.53	7.45	7.39

Все каталоги и инструкции здесь: <http://splitoff.ru/tehn-doc.html>

Model SRK60ZIX-S

Cool Mode

Air flow	Outdoor air temp.	Indoor air temp													
		21°CDB 14°CWB		23°CDB 16°CWB		26°CDB 18°CWB		27°CDB 19°CWB		28°CDB 20°CWB		31°CDB 22°CWB		33°CDB 24°CWB	
		TC	SHC	TC	SHC	TC	SHC	TC	SHC	TC	SHC	TC	SHC	TC	SHC
Hi 14.5 (m³/min)	10	6.76	4.98	7.08	4.90	7.34	5.03	7.46	4.96	7.59	4.88	7.81	4.98	8.02	4.81
	12	6.64	4.92	6.96	4.84	7.23	4.98	7.36	4.91	7.49	4.84	7.73	4.94	7.94	4.78
	14	6.51	4.84	6.83	4.78	7.13	4.93	7.26	4.87	7.40	4.80	7.64	4.91	7.86	4.75
	16	6.38	4.78	6.71	4.70	7.01	4.87	7.16	4.82	7.29	4.75	7.55	4.87	7.78	4.72
	18	6.25	4.71	6.58	4.64	6.90	4.82	7.05	4.76	7.19	4.71	7.46	4.83	7.69	4.68
	20	6.12	4.64	6.44	4.57	6.78	4.75	6.94	4.71	7.08	4.65	7.36	4.79	7.60	4.65
	22	5.98	4.56	6.30	4.51	6.66	4.70	6.83	4.66	6.97	4.60	7.26	4.75	7.50	4.60
	24	5.83	4.48	6.16	4.44	6.53	4.65	6.71	4.61	6.85	4.56	7.15	4.72	7.40	4.57
	26	5.69	4.41	6.02	4.36	6.41	4.59	6.59	4.56	6.73	4.51	7.04	4.65	7.30	4.53
	28	5.54	4.33	5.87	4.29	6.27	4.53	6.46	4.51	6.60	4.46	6.93	4.61	7.19	4.50
	30	5.38	4.25	5.71	4.22	6.14	4.47	6.33	4.45	6.48	4.40	6.82	4.57	7.08	4.46
	32	5.23	4.18	5.55	4.14	6.00	4.41	6.20	4.39	6.35	4.35	6.70	4.53	6.97	4.42
	34	5.06	4.09	5.39	4.06	5.85	4.34	6.07	4.34	6.21	4.29	6.57	4.49	6.85	4.39
	35	4.98	4.05	5.31	4.03	5.78	4.31	6.00	4.31	6.14	4.27	6.51	4.47	6.79	4.37
	36	4.90	4.01	5.22	3.99	5.71	4.28	5.93	4.28	6.07	4.24	6.45	4.44	6.73	4.34
	38	4.73	3.93	5.05	3.91	5.56	4.21	5.79	4.22	5.93	4.18	6.32	4.39	6.60	4.30
39	4.65	3.88	4.97	3.87	5.48	4.18	5.72	4.18	5.86	4.15	6.25	4.37	6.54	4.28	

Heat Mode

Air flow	outdoor air temp.	indoor air temp				
		16°CDB	18°CDB	20°CDB	22°CDB	24°CDB
Hi 17.0 (m³/min)	-15°CWB	4.18	4.09	4.00	3.92	3.83
	-10°CWB	4.73	4.65	4.59	4.47	4.38
	-5°CWB	5.13	5.05	4.95	4.90	4.82
	0°CWB	5.38	5.30	5.20	5.14	5.07
	5°CWB	6.85	6.77	6.73	6.60	6.51
	6°CWB	6.96	6.88	6.80	6.71	6.63
	10°CWB	7.39	7.32	7.28	7.18	7.11
	15°CWB	8.05	7.98	7.92	7.83	7.76
20°CWB	8.65	8.58	8.54	8.44	8.37	

1.5 Application data

1.5.1 Installation of indoor unit

RKY012A007

This instruction manual illustrates the method of installing an indoor unit.
For electrical wiring work, please see instructions set out on the backside.
For outdoor unit installation and refrigerant piping, please refer to the installation manual that comes with your outdoor unit.
A wired remote control unit is supplied separately as an optional part.

SAFETY PRECAUTIONS

- Please read these "Safety Precautions" first then accurately execute the installation work.
- For installing qualified personnel, take precautions in respect to themselves by using suitable protective clothing, gloves, etc., and then perform the installation works.
- Though the precautionary points indicated herein are divided under two headings, **⚠ WARNING** and **⚠ CAUTION**, those points which are related to the strong possibility of an installation done in error resulting in death, serious injury or environmental pollution are listed in the **⚠ WARNING** section. However, there is also a possibility of serious consequences in relationship to the points listed in the **⚠ CAUTION** section as well. In either case, important safety related information is indicated, so by all means, properly observe all that is mentioned.
- Please pay attention not to fall down the tools, etc. when installing the unit at the high position.
- After completing the installation, along with confirming that no abnormalities were seen from the operation tests. Please explain operating methods as well as maintenance methods to the user (customer) of this equipment, based on the user's manual. Moreover, ask the customer to keep this sheet together with the user's manual.
- If unusual noise can be heard during operation, consult the dealer.

⚠ WARNING

- To disconnect the appliance from the mains supply this appliance must be connected to the mains by means of a circuit breaker or a switch (use a recognized 16A) with a contact separation of at least 3mm.
- The appliance shall be installed in accordance with national wiring regulations.
- When a plug is connected to the power cord, a plug conforming to the IEC60884-1 standard must be used.
- This system should be applied to places as households, residences and the like. Application to interior environment such as engineering shop could cause equipment malfunction.
- Please entrust installation to either the company which sold you the equipment or to a professional contractor. Defects from improper installations can be the cause of water leakage, electric shocks and fires.
- Execute the installation accurately, based on following the installation manual. Again, improper installations can result in water leakage, electric shocks and fires.
- For installation, confirm that the installation site can sufficiently support heavy weight. When strength is insufficient, injury can result from a falling of the unit.
- For electrical work, please see that a licensed electrician executes the work while following the safety standards related to electrical equipment, and local regulations as well as the installation instructions, and that only exclusive use circuits are used.
Insufficient power source circuit capacity and defective installment execution can be the cause of electric shocks and fires.
- Accurately connect wiring using the proper cable, and insure that the external force of the cable is not conducted to the terminal connection part, through properly securing it. Improper connection or securing can result in heat generation or fire.
- Take care that wiring does not rise upward, and accurately install the lid/service panel. It's improper installation can also result in heat generation or fire.
- Always use accessory parts and authorized parts for installation construction. Using parts not authorized by this company can result in water leakage, electric shock, fire and refrigerant leakage.
- Ventilate the work area when refrigerant leaks during the operation.
Coming in contact with fire, refrigerant could generate toxic gas.
- Confirm after the foundation construction work that refrigerant does not leak.
If coming in contact with fire of a fan heater, a stove or a movable cooking stove, etc., refrigerant leaking in the room could generate toxic gas.
- Turn off the power source during working on the inside of the unit such as servicing or installing work.
This may cause electric shock.
- Use only pipe, flare nut and tools that have been designed to operate with R410A.
Using existing parts (R22) may cause the unit failure, even as due to serious accident such as explosion of the cooling cycle or injury etc.
- For pump down work, stop the compressor before removing the refrigerant pipe.
If the refrigerant pipe is removed when the compressor is in operation with the service valves open (liquid side and gas side), air would be mixed in the refrigerant circuit and this may cause explosion and injuries due to abnormal high pressure in the cooling cycle.
- Connect the pipes for refrigerant circuit securely in installation work before compressor is operated
If the compressor is operated when the service valve is open without connecting the pipe, this may cause frostbite and injuries due to refrigerant leakage rapidly. Also, the unit is absorbed the air etc., this may cause explosion and injuries due to abnormal high pressure in the cooling cycle.
- Tighten the flare nut by torque wrench with specified method.
If the flare nut were tightened with excess torque, this may cause burst and refrigerant leakage after a long period, and then, this may cause generate the harmful substance due to touch the flammable materials.
- Make sure there is no dust or clogging on both plug and socket nor loose connection of the socket before plugging of the power plug. Then, the power plug must be inserted tightly.
Accumulation of dust, clogging on the socket or plug, or loose installation of the socket may cause electric shock and fire. Replace the socket if it is loose.
- Do not open the service valves (liquid side and gas side) until refrigerant piping construction, air-tightness test and evacuation are completed
This may cause frostbite and injuries due to refrigerant leakage rapidly. Also, if the refrigerant gas leakage occurs during installing work, stop the work such as brazing work and then ventilation of the room. This may cause generate the toxic gas due to touch the flammable materials.
- Do not put the drain pipe directly into the ditch where toxic gas such as sulfur is generated.
Toxic gas would flow into the room. Also, this may cause corrosion of indoor unit, and malfunction or refrigerant leakage.
- Be sure to bring back the packing material, form polystyrene, band and vinyl back etc., of the indoor and/or outdoor units after complete the installation work, and then implement appropriate measures such as breaking them.
- When setting up or moving the location of the air conditioner, do not mix air etc. or anything other than the designated refrigerant (R410A) within the refrigeration cycle.
Rupture and injury caused by abnormal high pressure can result from such mixing.
- Do not processing, splice the power cord, or share a socket with other power plugs.
This may cause fire or electric shock due to defecting contact, defecting insulation and over-current etc.
- Do not bundling, winding or processing for the power cord. Or, do not deforming the power plug due to treat it
This may cause fire or heating.
- Do not vent R410A into the atmosphere: R410A is a fluorinated greenhouse gas, covered by the Kyoto Protocol with a Global Warming Potential (GWP) =1975
- Execute proper grounding. Do not connect the ground wire to a gas pipe, water pipe, lightning rod or a telephone ground wire. Improper placement of ground wires can result in electric shock.

⚠ CAUTION

- Please avoid installing this unit in the locations where oil splashes and moisture are abundant (e.g., kitchens, mechanical workshops) or where the outside air is likely to flow in. These locations may cause corrosion and lower performance of the heat exchanger and cause damage to plastic parts.
- Please avoid installing this unit in the locations with corrosive gases (such as sulfurous acid gas), inflammable gases (such as thinner, gasoline) and areas where there are possibilities of gas accumulation or where a volatile inflammable material is handled. These locations can cause corrosion to the heat exchanger and damage to plastic parts. Also, the inflammable gas could cause fire.
- Please avoid installing this unit in the vicinity of equipment generating electromagnetic waves such as hospital equipment or equipment generating high-frequency waves. A failure to observe this instruction may result in controller performance errors due to noise generation.
- Please avoid installing and using this unit in a place where it is subject to sea breezes (coastal area). Installation in such a place may result in the corrosion of exterior panels and the heat exchanger.
- Do not place the remote control at locations that receives direct sunlight. This may cause malfunction and deformation.
- Spatters from welding, etc., if hit the unit, can damage (pinhole) its drain pan and other components and cause a water leak. Care must be taken in performing a welding operation near this unit and take necessary precautions to prevent spatters from entering this unit.
- For installation work, be careful not to get injured with the heat exchanger, piping flare portion or screws etc.
- For the drain pipe, follow the installation manual to insure that it allows proper drainage and thermally insulate it to prevent condensation. Inadequate plumbing can result in water leakage and water damage to interior items.
- The installation of an earth leakage breaker is necessary depending on the established location of the unit. Not installing an earth leakage breaker may result in electric shock.
- When perform the air conditioner operation (cooling or drying operation) in which ventilator is installed in the room. In this case, using the air conditioner in parallel with the ventilator, there is the possibility that drain water may backflow in accordance with the room lapse into the negative pressure status. Therefore, set up the opening port such as incorporate the air into the room that may appropriate to ventilation (For example, Open the door a little). In addition, just as above, so set up the opening port if the room lapse into negative pressure status due to register of the wind for the high rise apartment etc.
- Secure the regulated space for inspection and maintenance
When it is not possible to keep enough space, this may cause injury due to falling from the installation place.
- To prevent the falling, institute the everlasting ladder and handrail etc., to the aisle when installing the outdoor unit in the location with rooftop or altitude.
Or, for surrounding of the outdoor unit, institute the fence and handrail etc., to the aisle to prevent the falling.
- Performing the heat insulation and condensation of the refrigerant piping
If the heat insulation and condensation of the refrigerant piping is not correctly, this may cause the water leakage, dew dropping and household wetting etc.
- Be careful not to injury due to damage of the unit installing work when leaving of the packaging materials.
- Do not install the unit where there is a concern about leakage of combustible gas.
The rare event of leaked gas collecting around the unit could result in an outbreak of fire.
- Do not touch the suction or aluminum fin on the outdoor unit
This may cause injury.
- Do not install the outdoor unit where is likely to be a nest for small animals
Small animals may come into the electronic components and may cause breakdown and fire. Also, instruct the user to keep the surroundings clean.
- Do not install the outdoor unit at the place where fan airflow falls on the garden tree etc.
This may cause damage to the garden tree etc., due to the fan airflow.
- Do not put anything on the outdoor unit and operating the unit.
This may cause damage the objects or injury due to falling to the object.

• Symbols which appear frequently in the text have the following meaning

- ⊘ Strictly prohibited
- ⚠ Observe instructions with great care
- ⚡ Provide proper earthing

CAUTIONS FOR INSTALLATION

- ⊘ The system should be applied to places as households, residences and the like.
- ⊘ The equipment shall be installed in accordance with national wiring regulations.
- ⊘ The connection to the fixed wiring of the mains supply must be made via a double pole isolating switch with a contact gap of at least 3mm in each pole.
- ⊘ When the outdoor unit has a possibility of being overturned or being displaced and fall from its original installation position, the outdoor unit should be fixed in its position by use of anchor bolts or wires.

BEFORE INSTALLATION

○ Before installation check that the power supply matches the air conditioner.

Standard accessories (Installation kit)		Q'ty
Accessories for indoor unit		
①	Installation board (Attached to the rear of the indoor unit)	1
②	Wireless remote control	1
③	Remote control holder	1
④	Tapping screws (for installation board 4dia. by 25mm)	4
⑤	Wood screw (for remote control switch holder 3.5(mm), by 16mm)	2
⑥	Battery [R03(AAA, Micro) 1.5V]	2
⑦	Air-cleaning filters	2
⑧	Filter holders (Attached to the front panel of indoor unit)	2
⑨	Insulation (#486 50 x 100 t3)	1

Option parts		Q'ty
④	Sealing plate	
⑤	Sleeve	1
⑥	Inclination plate	1
⑦	Putty	1
⑧	Drain hose (extention hose)	1
⑨	Piping cover (for insulation of connection piping)	1

Necessary tools for the installation work	
1	Plus headed driver
2	Knife
3	Saw
4	Tape measure
5	Hammer
6	Spanner wrench
7	Torque wrench (14.0 ~ 61.0N·m (1.4 ~ 6.1kgf·m))
8	Hole core drill (65mm in diameter)
9	Wrench key (Hexagon) [4m/m]
10	Flaring tool set (Designed specifically for R410A)
11	Gas leak detector (Designed specifically for R410A)
12	Gauge for projection adjustment (Used when flare is made by using conventional flare tool)
13	Pipe bender

SELECTION OF INSTALLATION LOCATION

(Install at location that meets the following conditions, after getting approval from the customer)

Indoor unit

- Where there is no obstructions to the air flow and where the cooled and heated air can be evenly distributed.
- A solid place where the unit or the wall will not vibrate.
- A place where there will be enough space for servicing. (Where space mentioned below can be secured)
- Where wiring and the piping work will be easy to conduct.
- The place where receiving part is not exposed to the direct rays of the sun or the strong rays of the street lighting.
- A place where it can be easily drained.
- A place separated at least 1m away from the television or the radio. (To prevent interference to images and sounds.)
- Places where this unit is not affected by the high frequency equipment or electric equipment.
- Avoid installing this unit in place where there is much oil mist.
- Places where there is no electric equipment or household under the installing unit.

Wireless remote control

- A place where the air conditioner can be received the signal surely during operating the wireless remote control.
- Places where there is no affected by the TV and radio etc.
- Do not place where exposed to direct sunlight or near heat devices such as a stove.

INSTALLATION OF INDOOR UNIT

Installation of Installation board

Look for the inside wall structures (Intermediats support or pillar and finally install the unit after level surface has been checked.)

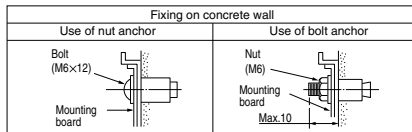
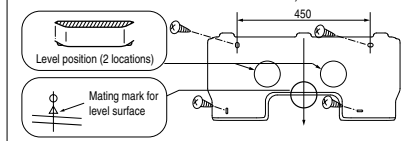

Drilling of holes and fixture of sleeve (Option parts)

When drilling the wall that contains a metal lath, wire lath or metal plate, be sure to use pipe hole sleeve sold separately.

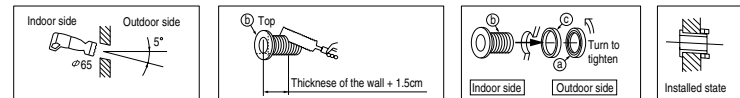

○ Drill a hole with whole core drill.

○ In case of rear piping draw out, cut off the lower and the right side portions of the sleeve collar.

Installing the support of piping

In case of piping in the right rear direction

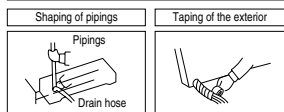

○ Hold the bottom of the piping and fix direction before stretching it and shaping it.

○ Tape only the portion that goes through the wall.
○ Always tape the wiring with the piping.

● Matters of special notice when piping from left or central/rear of this unit.

[Top view]

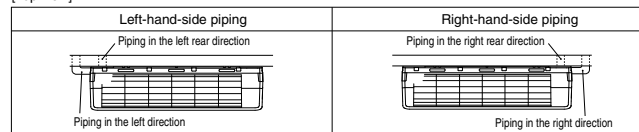

[Drain hose changing procedures]

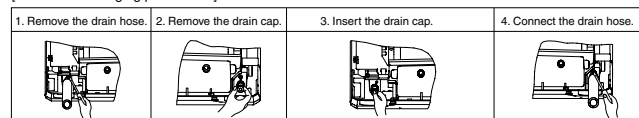

○ Remove the screw and drain hose, making it rotate.

○ Remove it with hand or pliers.

○ Insert the drain cap which was removed at procedure "2" securely using a hexagonal wrench etc.
Note: Be careful that if it is not inserted securely, water leakage may occur.

○ Insert the drain hose securely, making rotate. And install the screw.
Note: Be careful that if it is not inserted securely, water leakage may occur.

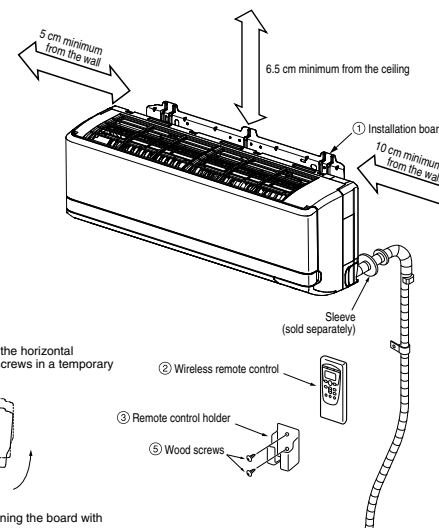

Relation between setting plate and indoor unit

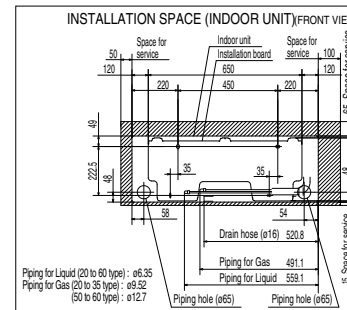

Fixing of indoor unit

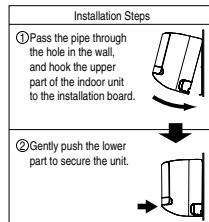
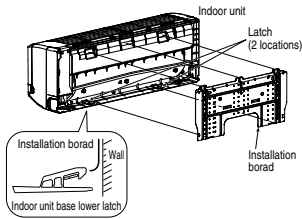

How to remove the indoor unit from the installation board

- 1 Push up at the marked portion of the indoor unit base lower latch, and slightly pull it toward you. (both right and left hand sides) (The indoor unit base lower latch can be removed from the installation board)
- 2 Push up the indoor unit upward. So the indoor unit will be removed from the installation board.

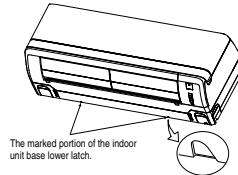

Since this air conditioner has been designed to collect dew drops on the rear surface to the drain pan, do not attach the power cord above the gutter.



Drainage

- Arrange the drain hose in a downward angle
- Avoid the following drain piping.

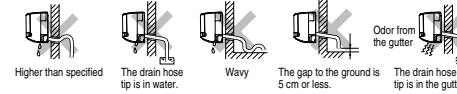

- Pour water to the drain pan in a downward angle under the heat exchanger, and ensure that the water is discharged outdoor.
- When the extended drain hose is indoor, always use a shield pipe (to be arranged by the user) and ensure it is thermally insulated

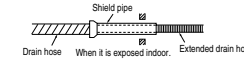

CONNECTION OF REFRIGERANT PIPINGS

Preparation Keep the openings of the pipes covered with tapes etc. to prevent dust, sand, etc. from entering them.

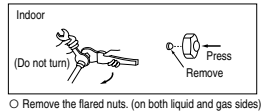

- Remove the flared nuts. (on both liquid and gas sides)

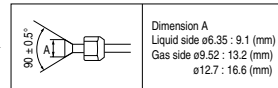

- Install the removed flared nuts to the pipes to be connected, then flared the pipes.

CAUTION
Do not apply refrigerating machine oil to the flared surface.

Flaring work

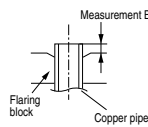

Copper pipe diameter	Measurement B (mm)	
	Clutch type flare tool for R410A	Conventional (R22) flare tool
ø6.35	Do not 0.0 - 0.5	Clutch type 1.0 - 1.5 Wing nut type 1.5 - 2.0
ø9.52	0.0 - 0.5	1.0 - 1.5 1.5 - 2.0
ø12.7	0.0 - 0.5	1.0 - 1.5 2.0 - 2.5

Use a flare tool designed for R410A or a conventional flare tool.
Please note that measurement B (protrusion from the flaring block) will vary depending on the type of a flare tool in use.
If a conventional flare tool is used, please use a copper pipe gauge or a similar instrument to check protrusion so that you can keep measurement B to a correct value.

CAUTION
Do not apply excess torque to the flared nuts. Otherwise, the flared nuts may check depending.

Connection

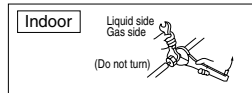

- Connect the pipes on both liquid and gas sides.
- Tighten the nuts to the following torque.
Liquid side (ø6.35) : 14.0 - 18.0 N·m (1.4 - 1.8 kgf·m)
Gas side (ø9.52) : 34.0 - 42.0 N·m (3.4 - 4.2 kgf·m)
(ø12.7) : 49.0 - 61.0 N·m (4.9 - 6.1 kgf·m)

Insulation of the connection portion

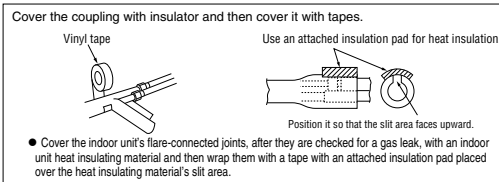

- Cover the indoor unit's flare-connected joints, after they are checked for a gas leak, with an indoor unit heat insulating material and then wrap them with a tape with an attached insulation pad placed over the heat insulating material's slit area.

Finishing work and fixing

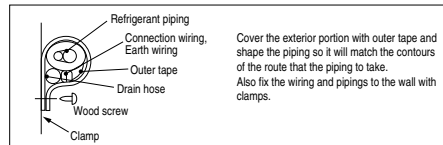

Cover the exterior portion with outer tape and shape the piping so it will match the contours of the route that the piping to take.
Also fix the wiring and pipings to the wall with clamps.

Open/close and detachment/attachment of the air inlet panel

- To open, pull the panel at both ends of lower part and release latches, then pull up the panel until you feel resistance.
(The panel stops at approx. 60° open position)
- To close, hold the panel at both ends of lower part to lower downward and push it slightly until the latch works.
- To remove, pull up the panel to the position shown in right illustration and pull it toward you.
- To install, insert the panel arm into the slit on the front panel from the position shown in right illustration, hold the panel at both ends of lower part, lower it downward slowly, then push it slightly until the latch works.

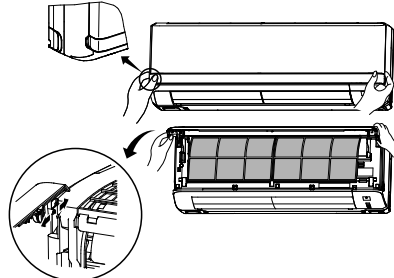

How to remove and fit the front panel

- Removing
 - 1 Remove the air inlet panel.
 - 2 Remove the 5 set screws.
 - 3 Remove the 4 latches in the upper section.
 - 4 Move the lower part of the panel forward and push upwards to remove.
- Fitting
 - 1 Do remove the air filter.
 - 2 Cover the body with the front panel.
 - 3 Fit the 4 latches in the upper section.
 - 4 Tighten the 5 set screws.
 - 5 Fit the air filter.
 - 6 Fit the air input panel.

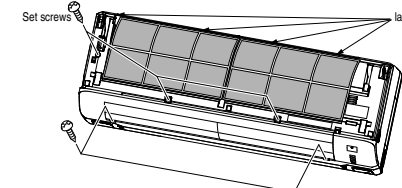

ELECTRICAL WIRING WORK

Preparation of indoor unit

Mounting of connecting wires

- ① Open the air inlet panel.
- ② Remove the service panel.
- ③ Remove the wiring clamp
- ④ Connect the connecting wire securely to the terminal block.
 - 1) Connect the connection wire securely to the terminal block. If the wire is not affixed completely, contact will be poor, and it is dangerous as the terminal block may heat up and catch fire.
 - 2) Take care not to confuse the terminal numbers for indoor and outdoor connections.
 - 3) Fix the connection wire using the wiring clamp.
- ⑤ Fix the connecting wire by wiring clamp.
- ⑥ Attach the service panel.
- ⑦ Close the air inlet panel.

CAUTION

In case of faulty wiring connection, the indoor unit stops, and then the run lamp turns on and the timer lamp blinks.

Use cables for interconnection wiring to avoid loosening of the wires.
CENELEC code for cables Required field cables.

H05	RNR4G1.5 (example) or 24SIEC57
H	Harmonized cable type
05	300/500 volts
R	Natural-and/or synth. rubber wire insulation
N	Polychloroprene rubber conductors insulation
R	Stranded core
4or5	Number of conductors
G	One conductor of the cable is the earth conductor (yellow/green)
1.5	Section of copper wire (mm ²)

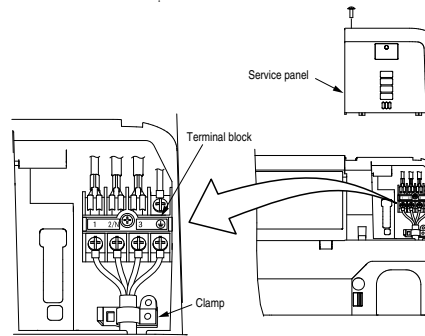

Installing the air-cleaning filters

1. Open the air inlet panel and remove the air filters.
2. Install the filter holders, with the air-cleaning filters installed in the holders.
 - Each air-cleaning filter can be installed in the left or right filter holder.
3. Install the air filters and close the inlet panel.

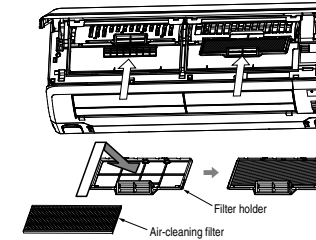

INSTALLATION OF REMOTE CONTROL SWITCH

Mounting method of battery

- Uncover the wireless remote control, and mount the batteries [R03(AAA, Micro), ×2 pieces] in the body regularly. (Fit the poles with the indication marks, ⊕ & ⊖ without fall)

CAUTION

Do not use new and old batteries together.

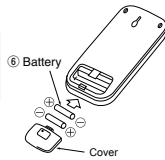

Fixing to pillar or wall

- Conventionally, operate the remote control switch by holding in your hand.
- Avoid installing it on a clay wall etc.

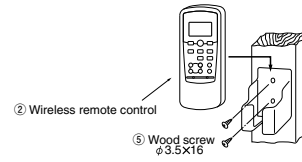

INSTALLATION TEST CHECK POINTS

Check the following points again after completion of the installation, and before turning on the power. Conduct a test run again and ensure that the unit operates. At the same time, explain to the customer how to use the unit and how to take care of the unit following the user's manual.

After installation

- The power supply voltage is correct as the rating.
- No gas leaks from the joints of the operational valve.
- Power cables and crossover wires are securely fixed to the terminal board.
- Operational valve is fully open.
- The pipe joints for indoor and outdoor pipes have been insulated.

Test run

- Air conditioning operation is normal.
- No abnormal noise.
- Water drains smoothly.
- Protective functions are not working.
- The remote control is normal.
- Operation of the unit has been explained to the customer. (Three-minutes restart preventive timer)
When the air conditioner is restarted or when changing the operation, will not start operating for approximately 3 minutes. This is to protect the unit and it is not a malfunction.

HOW TO RELOCATE OR DISPOSE OF THE UNIT

- In order to protect the environment, be sure to pump down (recovery of refrigerant).
- Pump down is the method of recovering refrigerant from the indoor unit to the outdoor unit when the pipes are removed from the unit.

-How to pump down-

- ① Connect charge hose to service port of outdoor unit.
- ② Liquid side : Close the liquid valve with hexagon wrench key.
Gas side : Fully open the gas valve
Carry out cooling operation . (If indoor temperature is low, operate forced cooling operation.)
- ③ After low pressure gauge become 0.01MPa, stop cooling operation and close the gas valve.

- Forced cooling operation
Turn on a power supply again after a while after turn off a power supply. Then press continually the ON/OFF button 5 seconds or more.

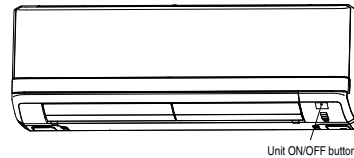

CONCERNING TERMINAL CONNECTION FOR AN INTERFACE

- ① Remove the front panel and lid of control.
- ② There is a terminal (respectively marked with CNS) for the indoor control board.
In connecting an interface, connect to the respective terminal securely with the connection harness supplied with an optional "Interface connection kit SC-BIKN-E" and fasten the connection harness onto the indoor control box with the clamp supplied with the kit.
For more details, please refer to the user's manual of your "Interface connection kit SC-BIKN-E".

1.5.2 Installation of outdoor unit

Models SRC20ZIX-S, 25ZIX-S, 35ZIX-S

RWC012A030 

Model 20 · 25 · 35

Designed for R410A refrigerant

Check before installation work

- Model name and power source
- Refrigerant piping length
- Piping, wiring and miscellaneous small parts
- Indoor unit installation manual



Accessories for outdoor unit		
①	Gromet (Heat pump type only)	1
②	Drain elbow (Heat pump type only)	1

Option parts		Q'ty
(a)	Sealing plate	1
(b)	Sleeve	1
(c)	Inclination plate	1
(d)	Putty	1
(e)	Drain hose (extension hose)	1
(f)	Piping cover (for insulation of connection piping)	1

Necessary tools for the installation work	
1	Plus headed driver
2	Knife
3	Saw
4	Tape measure
5	Hammer
6	Spanner wrench
7	Torque wrench (14.0~ 62.0N · m (1.4 ~ 6.2kgf · m))
8	Hole core drill (65mm in diameter)
9	Wrench key (Hexagon) [4 m/m]
10	Vacuum pump
11	Vacuum pump adapter (Anti-reverse flow type) (Designed specifically for R410A)
12	Gauge manifold (Designed specifically for R410A)
13	Charge hose (Designed specifically for R410A)
14	Flaring tool set (Designed specifically for R410A)
15	Gas leak detector (Designed specifically for R410A)
16	Gauge for projection adjustment (Used when flare is made by using conventional flare tool)





- © This installation manual deals with outdoor units and general installation specifications only. For indoor units, refer to the respective installation manuals supplied with the units.
 © Read this manual carefully before you set to installation work and carry it out according to the instructions contained in this manual.



PRECAUTIONS FOR SAFETY

- When installing the equipment, carefully read the Precautions for safety and make sure that safety is maintained.
- The safety items contain important information regarding safety. Be sure to follow them. The symbols used and their meanings are as follows.
 -  **WARNING** : Improper installation could result in serious accident causing death, serious injury or environmental pollution.
 -  **CAUTION** : Improper installation could result in serious accident.
- After installation, along with confirming that no abnormalities were seen from the operation test. Explain operating methods as well as maintenance methods to the user of this equipment, based on the owner's manual.
- Ask the customer to keep this manual together with the operation manual.
- In installing the unit, you must also take thorough safety precautions to protect your person. A failure to observe any safety instruction listed under "  Caution" can also result in a serious consequence depending on the circumstances. Please observe all these instructions, because they include important points concerning safety.
- The meanings of "Marks" used here are as follows:

	Never do it under any circumstances.	 	Always do it according to the instruction.
---	--------------------------------------	---	--

- Beware of danger from a dropped tool or the like in installing the unit in an elevated position.
- When the air conditioning unit makes abnormal sounds in operation, consult with your dealer.

 WARNING	
	<ul style="list-style-type: none"> ● To disconnect the appliance from the mains supply this appliance must be connected to the mains by means of a circuit breaker or a switch (use a recognized 16A) with a contact separation of at least 3mm. ● The appliance shall be installed in accordance with national wiring regulations. ● This system should be applied to places as households, residences and the like. Application to inferior environment such as engineering shop could cause equipment malfunction. ● Ask your dealer or a specialized service provider to install the unit. Improper installation work performed on the part of a user can result in a water leak, electric shock or fire. ● Carry out installation work properly according to this installation manual. Improper installation work can result in a water leak, electric shock, or fire. ● Always turn off power before you work inside the unit such as for installation or servicing. A failure to observe this instruction can result in an electric shock. ● Install the unit securely onto a structure that is strong enough to sustain its weight. Insufficient strength or improper installation can cause a fall of the unit and resultant injury. ● Electrical installation work must be performed according to the installation manual as dedicated circuits exclusively for the air conditioning system in compliance with the applicable "Technical standards for electrical installation" and "Indoor wiring regulations." A defect in power supply circuits such as insufficient capacity or improper installation can cause an electrical shock or fire. ● Always connect between indoor and outdoor units securely with specified cables. Never use an intermediate connection or stranded wire for this purpose. Fasten cables securely so that the terminal block may not be subject to external force working through cables. Improper connection or fastening can cause heat generation and a resultant fire. ● Neatly arrange the cables connecting between indoor and outdoor units so that they may not get loose, and put on the lid and/or service panel securely. Improper installation can cause heat generation at terminal connections and a resultant fire or electric shock. ● Use only parts supplied with the unit and approved supply parts for installation work. A failure to use genuine parts approved by the manufacturer may result in a fall of the unit, a water leak, a fire, an electric shock, a refrigerant leak, substandard performance or a control failure. ● If refrigerant gas leaks during installation work, ventilate the room. Refrigerant gas, if it comes into contact with bare fire, can cause the generation of a toxic gas. ● Use pipes, flare nuts and tools specifically designed for R410A. The diversion of existing materials (designed for R22) can result in a unit failure as well as a serious accident such as refrigeration cycle rupture or injury. ● In carrying out a pump-down process, stop the compressor before you detach the refrigerant pipe. If you detach the pipe with the compressor running and the operation valves (liquid and gas sides) open, an abnormal pressure build-up will occur in the refrigeration cycle, which can result in pipe rupture or injury. ● In installing the unit, be sure to attach the refrigerant pipe before operating the compressor. If you run the compressor without attaching the refrigerant pipe and with the operation valves (liquid and gas sides) open, you may incur frost bite or injury from an abrupt refrigerant outflow. An abnormal pressure build-up may also occur in the refrigeration cycle as a result of the inhalation of air, which can result in pipe rupture or injury. ● Tighten a flare nut with a torque wrench in a specified manner. Over-tightening a flare nut can cause a refrigerant gas leak from breakage after years of operation and the generation of a toxic product, if refrigerant gas comes into contact with bare fire. ● In inserting the power cable plug, make sure that no anomalies such as dust deposits, socket clogging or wobble are found in both the plug and outlet and insert the plug fully to the roots of its blades. Dust deposits, clogging or wobble can result in an electric shock or fire. If the outlet is loose, change it with a new one. ● Never open the operation valves (either liquid or gas side) until refrigerant pipe installation work, an air-tightness test and an air purge are completed. A failure to observe this instruction can result in frost bite or injury from an abrupt refrigerant outflow. If refrigerant gas leaks during installation work, immediately stop pipe blazing and other work and ventilate the room.
	<ul style="list-style-type: none"> ● Do not run the drain piping directly into the sewer where a toxic gas such as sulfuric gas is generated. This will pose a risk of a toxic gas flowing back into the room. This can also cause the corrosion of the indoor unit and a resultant unit failure or refrigerant leak. ● You must collect, bring back and shred or otherwise properly dispose of all packaging materials, expanded polystyrene, bands, vinyl bags and so on used for the transportation of the indoor and outdoor units after installation work. ● In installing or transferring an air conditioning system, never allow air or other foreign matters than specified refrigerant (R410A) to get into the refrigerant cycle (piping). If air or other foreign matters gets into the refrigerant cycle, an abnormal pressure build-up will occur, which can result in pipe rupture or injury. ● Never modify the power cord, introduce an intermediate connection or connect it in a daisy chain. A failure to observe this instruction can result in a fire or electric shock from improper contact, improper insulation, excessive current beyond rating, etc. ● Never bundle, wind or modify the power cord. Do not step onto the power plug or otherwise deform it. A failure to observe this instruction can result in heat generation or ignition.
	<ul style="list-style-type: none"> ● Ensure that the unit is properly grounded. Do not connect the grounding wire to a gas pipe, water pipe, lightning rod, or telephone ground wire. If a defect is in a ground, it will become a cause of an electric shock at the time of failure or a short circuit.

 CAUTION	
	<ul style="list-style-type: none"> ● Take sufficient care so that you may not incur injury from heat exchanger fins, pipe flares and screws during work. ● Install drain piping according to the installation manual to ensure good drainage, and give it heat insulation to prevent condensation. Improper installation can result in a flood of water in the room and soaked household effects. ● When the unit is installed in a humid or damp place, the installation of an earth leakage breaker is essential. A failure to install an earth leakage breaker can cause an electric shock. ● When the air conditioning system is installed in a room equipped with a ventilating fan and it is used (for a cooling or dehumidifying operation) simultaneously with the ventilating fan, the room may have a negative air pressure relative to the exterior, which can cause a reverse flow of drain water. Make sure that the room has an opening that allows the inflow of as much air as discharged by the ventilation fan. (For example, open the door a little) Similarly, provide an adequate opening, if a room has a negative air pressure relative to the exterior due to the effect of winds in a high-rise condominium building or the like. ● Secure a service space for inspection and maintenance as specified in the manual. An insufficient service space can result in a fall from the installation point and resultant injury. ● When the outdoor unit is installed on a roof top or in an elevated position, provide permanent ladders and handrails along the access path and fences or handrails surrounding the outdoor unit. ● Dress the refrigerant piping with a heat insulation material to prevent condensation. Improper heat insulation given to refrigerant piping for condensation prevention can result in leaking or dripping water soaking household effects. ● In removing packaging materials, take sufficient care so as not to damage the contents or incur injury from such work.
	<ul style="list-style-type: none"> ● Do not install the unit in the place where a risk of inflammable gas leaks exists. Should gas leak and gather around the unit, it can cause the ignition of gas. ● Do not touch the air intake and aluminum fins of the outdoor unit. You may incur injury if you touch them. ● Do not install the outdoor unit in a place where small animals are likely to inhabit. If they enter the unit and touch electrical parts inside, they may cause a unit failure or fire. Please ask the customer to keep the surroundings clean. ● Do not install the outdoor unit where its fan winds directly hit a plant etc. Fan winds can affect adversely to the plant etc. ● Do not operate the outdoor unit with any article placed on it. A failure to observe this instruction can result in a fall of the article and resultant property damage or personal injury.

Notabilia as a unit designed for R410A

- Do not use any refrigerant other than R410A. R410A will rise to pressure about 1.6 times higher than that of a conventional refrigerant. A cylinder containing R410A has a pink indication mark on the top.
- A unit designed for R410A has adopted a different size indoor unit operation valve charge port and a different size check joint provided in the unit to prevent the charging of a wrong refrigerant by mistake. The processed dimension of the flared part of a refrigerant pipe and a flare nut's parallel side measurement have also been altered to raise strength against pressure. Accordingly, you are required to arrange dedicated R410A tools listed in the table on the right before installing or servicing this unit.
- Do not use a charge cylinder. The use of a charge cylinder will cause the refrigerant composition to change, which results in performance degradation.
- In charging refrigerant, always take it out from a cylinder in the liquid phase.
- All indoor units must be models designed exclusively for R410A. Check connectable indoor unit models in a catalog, etc. (A wrong indoor unit, if connected into the system, will impair proper system operation)

1. HAULAGE AND INSTALLATION (Take particular care in carrying in or moving the unit, and always perform such an operation with two or more persons)

CAUTION When a unit is hoisted with slings for haulage, take into consideration the offset of its gravity center position. If not properly balanced, the unit can be thrown off-balance and fall.

1) Delivery

- Deliver the unit as close as possible to the installation site before removing it from the packaging.
- When you have to unpack the unit for a compelling reason before you haul it to the installation point, hoist the unit with nylon slings or ropes and protection pads so that you may not damage the unit.

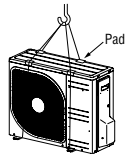

2) Portage

- The right hand side of the unit as viewed from the front (diffuser side) is heavier. A person carrying the right hand side must take heed of this fact. A person carrying the left hand side must hold with his right hand the handle provided on the front panel of the unit and with his left hand the corner column section.

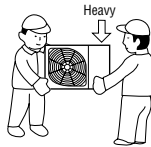

3) Selecting the installation location

Be careful of the following conditions and choose an installation place.

- Where air is not trapped.
- Where the installation fittings can be firmly installed.
- Where wind does not hinder the intake and outlet pipes.
- Out of the heat range of other heat sources.
- A place where stringent regulation of electric noises is applicable.
- Where it is safe for the drain water to be discharged.
- Where noise and hot air will not bother neighboring residents.
- Where snow will not accumulate.
- Where strong winds will not blow against the outlet pipe.
- A place where no TV set or radio receiver is placed within 5m. (If electrical interference is caused, seek a place less likely to cause the problem)
- If a operation is conducted when the outdoor air temperature is -5°C lower, the outdoor unit should be installed at a place where it is not influenced by natural wind.
- Where it is likely that the unit is subjected to strong winds, provide wind guards according to the following guidelines. Strong winds can cause performance degradation, an accidental stop due to a rise of high pressure and a broken fan.

1. Place the unit outlet pipe perpendicular to the wind direction.

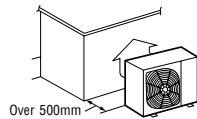

2. Install so the direction of the air from the blowing outlet will be perpendicular to the direction of the wind.

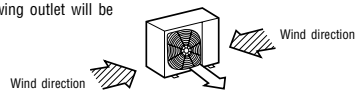

4) Installation space

- Walls surrounding the unit in the four sides are not acceptable.
- There must be a 1-meter or larger space in the above.
- When more than one unit are installed side by side, provide a 250mm or wider interval between them as a service space. In order to facilitate servicing of controllers, please provide a sufficient space between units so that their top plates can be removed easily.
- Where a danger of short-circuiting exists, install guide louvers.
- When more than one unit are installed, provide sufficient intake space consciously so that short-circuiting may not occur.
- Where piling snow can bury the outdoor unit, provide proper snow guards.

Size	Example installation	Model 20, 25, 35 (mm)			
		I	II	III	IV
L1	Open	280	280	180	
L2	100	75	Open	Open	
L3	100	80	80	80	
L4	250	Open	250	Open	

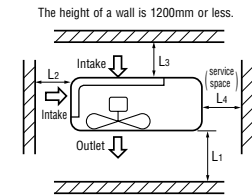

5) Installation

① Anchor bolt fixed position

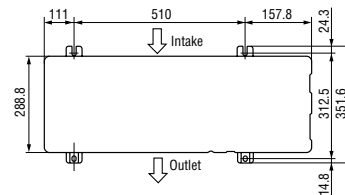

② Notabilia for installation

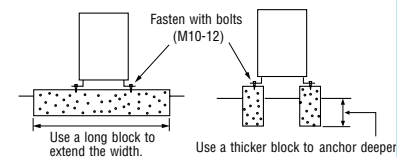

- In installing the unit, fix the unit's legs with bolts specified on the left.
- The protrusion of an anchor bolt on the front side must be kept within 15 mm.
- Securely install the unit so that it does not fall over during earthquakes or strong winds, etc.
- Refer to the above illustrations for information regarding concrete foundations.
- Install the unit in a level area. (With a gradient of 5 mm or less.)
Improper installation can result in a compressor failure, broken piping within the unit and abnormal noise generation.

2. REFRIGERANT PIPING WORK

1) Restrictions on unit installation and use

- Check the following points in light of the indoor unit specifications and the installation site.
- Observe the following restrictions on unit installation and use. Improper installation can result in a compressor failure or performance degradation.
- Additional refrigerant charge is not required at all.

Restrictions		Dimensional restrictions	Marks appearing in the drawing on the right
Main pipe length		15m or less	L
Elevation difference between indoor and outdoor units	When the outdoor unit is positioned higher,	10m or less	H
	When the outdoor unit is positioned lower,	10m or less	H

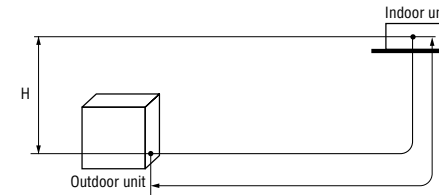

CAUTION ● The use restrictions appearing in the table above are applicable to the standard pipe size combinations shown in the table below.

2) Determination of pipe size

- Determine refrigerant pipe size pursuant to the following guidelines based on the indoor unit specifications.

	Model 20, 25, 35	
	Gas pipe	Liquid pipe
Outdoor unit connected	φ 9.52 Flare	φ 6.35 Flare
Refrigerant piping (branch pipeL)	φ 9.52	φ 6.35
Indoor unit connected	φ 9.52	φ 6.35

When pipe is brazing.

About brazing

Brazing must be performed under a nitrogen gas flow.

Without nitrogen gas, a large quantity of foreign matters (oxidized film) are created, causing a critical failure from capillary tube or expansion valve clogging.

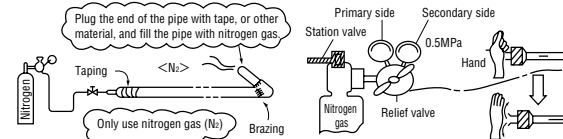

3) Refrigerant pipe wall thickness and material

- Select refrigerant pipes of the table shown on the right wall thickness and material as specified for each pipe size.

NOTE ● Select pipes having a wall thickness larger than the specified minimum pipe thickness.

Pipe diameter [mm]	6.35	9.52
Minimum pipe wall thickness [mm]	0.8	0.8
Pipe material*	O-type pipe	O-type pipe

*Phosphorus deoxidized seamless copper pipe ICS 23.040.15, ICS 77.150.30

4) On-site piping work

IMPORTANT Take care so that installed pipes may not touch components within a unit. If touching with an internal component, it will generate abnormal sounds and/or vibrations.

How to remove the side cover Please remove the screw of a side cover and remove to the front.

- Carry out the on site piping work with the operation valve fully closed.
- Give sufficient protection to a pipe end (compressed and blazed, or with an adhesive tape) so that water or foreign matters may not enter the piping.
- Bend a pipe to a radius as large as practical.(R100~R150) Do not bend a pipe repeatedly to correct its form.
- Flare connection is used between the unit and refrigerant pipe. Flare a pipe after engaging a flare nut onto it. Flare dimensions for R410A are different from those for conventional R407C. Although we recommend the use of flaring tools designed specifically for R410A, conventional flaring tools can also be used by adjusting the measurement of protrusion B with a protrusion control gauge.

- Tighten a flare joint securely with a double spanner.

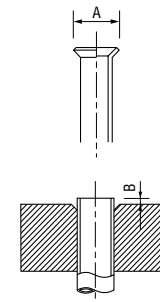
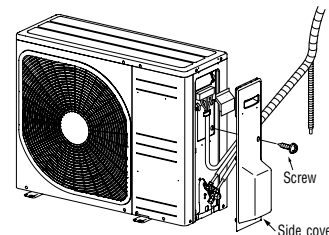

Flared pipe end : A (mm)

Copper pipe outer diameter	A
φ6.35	9.1
φ9.52	13.2

Copper pipe protrusion for flaring : B (mm)

Copper pipe outer diameter	In the case of a rigid (clutch) type	
	With an R410A tool	With a conventional tool
φ6.35	0~0.5	1.0~1.5
φ9.52		

CAUTION Do not apply force beyond proper fastening torque in tightening the flare nut.

Fix both liquid and gas service valves at the valve main bodies as illustrated on the right, and then fasten them, applying appropriate fastening torque.

Operation valve size (mm)	Tightening torque (N·m)	Tightening angle (°)	Recommended length of a tool handle (mm)
φ6.35 (1/4")	14~18	45~60	150
φ9.52 (3/8")	34~42	30~45	200

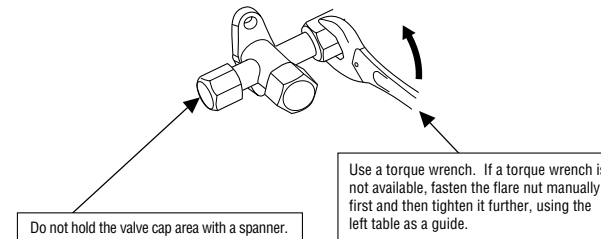

5) Air tightness test

- ① Although outdoor and indoor units themselves have been tested for air tightness at the factory, check the connecting pipes after the installation work for air tightness from the operation valve's check joint equipped on the outdoor unit side. While conducting a test, keep the operation valve shut all the time.
 - a) Raise the pressure to 0.5 MPa, and then stop. Leave it for five minutes to see if the pressure drops.
 - b) Then raise the pressure to 1.5 MPa, and stop. Leave it for five more minutes to see if the pressure drops.
 - c) Then raise the pressure to the specified level (4.15 MPa), and record the ambient temperature and the pressure.
 - d) If no pressure drop is observed with an installation pressurized to the specified level and left for about one day, it is acceptable. When the ambient Temperature fall 1°C, the pressure also fall approximately 0.01 MPa. The pressure, if changed, should be compensated for.
 - e) If a pressure drop is observed in checking e) and a) – d), a leak exists somewhere. Find a leak by applying bubble test liquid to welded parts and flare joints and repair it. After repair, conduct an air-tightness test again.
- ② In conducting an air-tightness test, use nitrogen gas and pressurize the system with nitrogen gas from the gas side. Do not use a medium other than nitrogen gas under any circumstances.

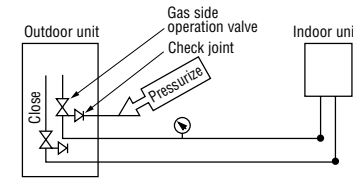

6) Evacuation

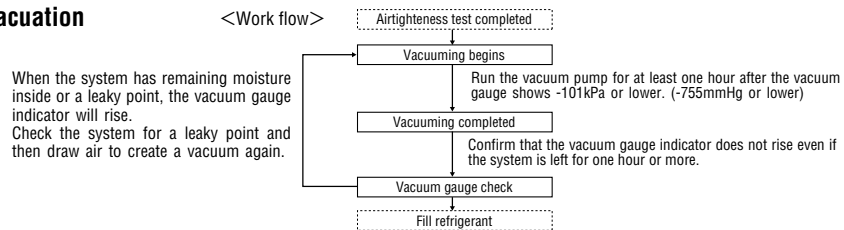

Pay attention to the following points in addition to the above for the R410A and compatible machines.

- To prevent a different oil from entering, assign dedicated tools, etc. to each refrigerant type. Under no circumstances must a gauge manifold and a charge hose in particular be shared with other refrigerant types (R22, R407C, etc.).
- Use a counterflow prevention adapter to prevent vacuum pump oil from entering the refrigerant system.

7) Heating and condensation prevention

- (1) Dress refrigerant pipes (both gas and liquid pipes) for heat insulation and prevention of dew condensation.
 - Improper heat insulation/anti-dew dressing can result in a water leak or dripping causing damage to household effects, etc.
- (2) Use a heat insulating material that can withstand 120°C or a higher temperature. Poor heat insulating capacity can cause heat insulation problems or cable deterioration.
 - All gas pipes must be securely heat insulated in order to prevent damage from dripping water that comes from the condensation formed on them during a cooling operation or personal injury from burns because their surface can reach quite a high temperature due to discharged gas flowing inside during a heating operation.
 - Wrap indoor units' flare joints with heat insulating parts (pipe cover) for heat insulation (both gas and liquid pipes).
 - Give heat insulation to both gas and liquid side pipes. Bundle a heat insulating material and a pipe tightly together so that no gaps may be left between them and wrap them together with a connecting cable by a dressing tape.
 - **Both gas and liquid pipes need to be dressed with 20 mm or thicker heat insulation materials above the ceiling where relative humidity exceeds 70%.**

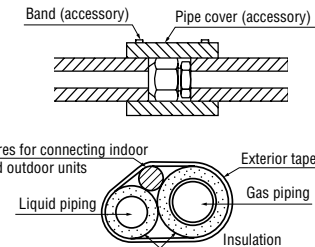

3. DRAIN PIPING WORK

- Execute drain piping by using a drain elbow and drain grommets supplied separately as optional parts, where water drained from the outdoor unit is a problem.

Where you are likely to have several days of sub-zero temperatures in a row, do not use a drain elbow and drain grommets. (There is a risk of drain water freezing inside and blocking the drain.)

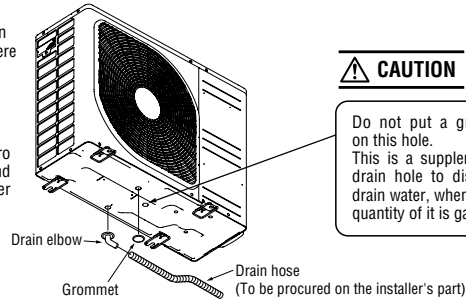

- When condensed water needs to be led to a drain, etc., install the unit on a flat base (supplied separately as an optional part) or concrete blocks. Then, please secure space for the drain elbow and the drain hose.

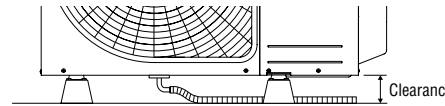

4. ELECTRICAL WIRING WORK For details of electrical cabling, refer to the indoor unit installation manual.

Electrical installation work must be performed by an electrical installation service provider qualified by a power provider of the country. Electrical installation work must be executed according to the technical standards and other regulations applicable to electrical installations in the country.

- Do not use any supply cord lighter than one specified in parentheses for each type below.
 - braided cord (code designation 60245 IEC 51),
 - ordinary tough rubber sheathed cord (code designation 60245 IEC 53)
 - flat twin tinsel cord (code designation 60227 IEC 41);
- Use polychloroprene sheathed flexible cord (code designation 60245 IEC57) for supply cords of parts of appliances for outdoor use.
- Ground the unit. Do not connect the grounding wire to a gas pipe, water pipe, lightning rod or telephone grounding wire.
 - If improperly grounded, an electric shock or malfunction may result.
- A grounding wire must be connected before connecting the power cable. Provide a grounding wire longer than the power cable.
- The installation of an impulse withstanding type earth leakage breaker is necessary. A failure to install an earth leakage breaker can result in an accident such as an electric shock or a fire.
- Do not turn on the power until the electrical work is completed.
- Do not use a condensive capacitor for power factor improvement under any circumstances. (It does not improve power factor, while it can cause an abnormal overheat accident)
- For power supply cables, use conduits.
- Do not lay electronic control cables (remote control and signaling wires) and other cables together outside the unit. Laying them together can result in the malfunctioning or a failure of the unit due to electric noises.
- Fasten cables so that they may not touch the piping, etc.
- When cables are connected, make sure that all electrical components within the electrical component box are free of loose connector coupling or terminal connection and then attach the cover securely. (Improper cover attachment can result in malfunctioning or a failure of the unit, if water penetrates into the box.)
- Always use a three-core cable for an indoor-outdoor connecting cable. Never use a shield cable.

CAUTION

In case of faulty wiring connection, the indoor unit stops, and then the run lamp turns on and the timer lamp blinks.

Use cables for interconnection wiring to avoid loosening of the wires. CENELEC code for cables Required field cables.

H05	RNR3G1.5 (Example) or 245IEC57
H	Harmonized cable type
05	300/500 volts
R	Natural-and/or synth. rubber wire insulation
N	Polychloroprene rubber conductors insulation
R	Stranded core
4or5	Number of conductors
G	One conductor of the cable is the earth conductor (yellow/green)
1.5	Section of copper wire (mm ²)

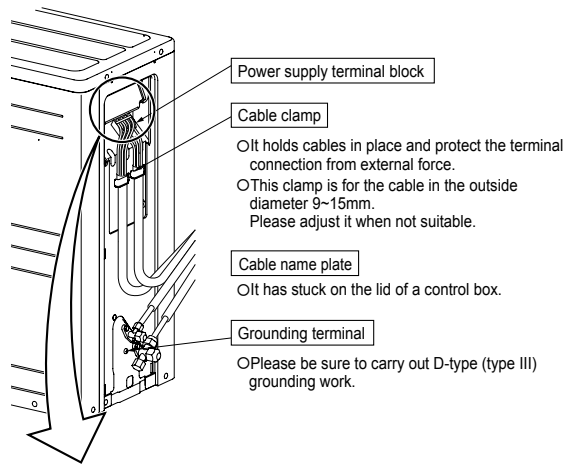

Power cable, indoor-outdoor connecting wires

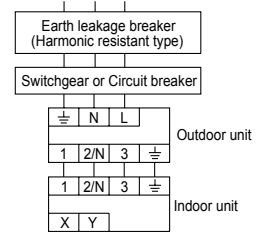

● Always perform grounding system installation work with the power cord unplugged.

CAUTION Always use an earth leakage circuit breaker designed for inverter circuits to prevent a faulty operation.

Phase	Model	Earth leakage breaker	Switchgear or Circuit Breaker		Power source (minimum)	Interconnecting and grounding wires (minimum)
			Switch breaker	Over current protector rated capacity		
Single-phase	20	15A,30mA, 0.1sec or less	30A	16A	2.0mm ²	1.5mm ² ×4
	25					
	35					

- The specifications show in the above table are for units without heaters. For units with heaters, refer to the installation instructions or the construction instructions of the indoor unit.
- Switchgear or Circuit breaker capacity which is calculated from MAX. over current should be chosen along the regulations in each country.
- The cable specifications are based on the assumption that a metal or plastic conduit is used with no more than three cables contained in a conduit and a voltage drop is 2%. For an installation falling outside of these conditions, please follow the internal cabling regulations. Adapt it to the regulation in effect in each country.

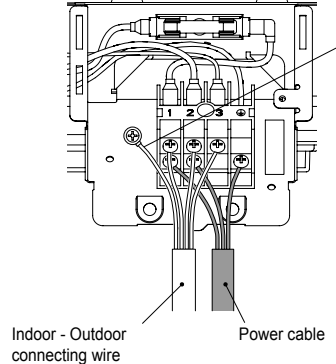

CAUTION

Please connect the earthed line of indoor and outdoor connecting wire to a bracket part of the illustration.

power cable, indoor - outdoor connecting wire circuit diagram

INSTALLATION TEST CHECK POINTS

Check the following points again after completion of the installation, and before turning on the power. Conduct a test run again and ensure that the unit operates properly. Explain to the customer how to use the unit and how to take care of the unit following the instruction manual.

After installation

- | | |
|---|---|
| <input type="checkbox"/> Power cables and crossover wires are securely fixed to the terminal block. | <input type="checkbox"/> The pipe joints for indoor and outdoor pipes have been insulated. |
| <input type="checkbox"/> The power supply voltage is correct as the rating. | <input type="checkbox"/> The reverse flow check cap is attached. |
| <input type="checkbox"/> The drain hose is fixed securely. | <input type="checkbox"/> The cover of the pipe cover (A) faces downward to prevent rain from entering. |
| <input type="checkbox"/> Operational valve is fully open. | <input type="checkbox"/> Gaps are properly sealed between the pipe covers (A) (B) and the wall surface / pipes. |
| <input type="checkbox"/> No gas leaks from the joints of the operation valve. | |

Check before installation work

- Model name and power source
- Refrigerant piping length
- Piping, wiring and miscellaneous small parts
- Indoor unit installation manual



Accessories for outdoor unit		
①	Gromet (Heat pump type only)	4
②	Drain elbow (Heat pump type only)	1

Option parts		Q'ty
Ⓐ	Sealing plate	1
Ⓑ	Sleeve	1
Ⓒ	Inclination plate	1
Ⓓ	Putty	1
Ⓔ	Drain hose (extension hose)	1
Ⓕ	Piping cover (for insulation of connection piping)	1

Necessary tools for the installation work	
1	Plus headed driver
2	Knife
3	Saw
4	Tape measure
5	Hammer
6	Spanner wrench (14.0~ 62.0N · m (1.4 ~ 6.2kgf · m))
7	Torque wrench
8	Hole core drill (65mm in diameter)
9	Wrench key (Hexagon) [4 m/m]
10	Vacuum pump
11	Vacuum pump adapter (Anti-reverse flow type) (Designed specifically for R410A)
12	Gauge manifold(Designed specifically for R410A)
13	Charge hose(Designed specifically for R410A)
14	Flaring tool set(Designed specifically for R410A)
15	Gas leak detector(Designed specifically for R410A)
16	Gauge for projection adjustment (Used when flare is made by using conventional flare tool)

- Ⓞ This installation manual deals with outdoor units and general installation specifications only. For indoor units, refer to the respective installation manuals supplied with the units.
- Ⓞ Read this manual carefully before you set to installation work and carry it out according to the instruction contained in this manual.

PRECAUTIONS FOR SAFETY

- When installing the equipment, carefully read the Precautions for safety and make sure that safety is maintained.
- The safety items contain important information regarding safety. Be sure to follow them. The symbols used and their meanings are as follows.
 -  **WARNING** : Improper installation could result in serious accident causing death, serious injury or environmental pollution.
 -  **CAUTION** : Improper installation could result in serious accident.
- After installation, along with confirming that no abnormalities were seen from the operation test. Explain operating methods as well as maintenance methods to the user of this equipment, based on the owner's manual.
- Ask the customer to keep this manual together with the operation manual.
- In installing the unit, you must also take thorough safety precautions to protect your person. A failure to observe any safety instruction listed under "⚠ Caution" can also result in a serious consequence depending on the circumstances. Please observe all these instructions, because they include important points concerning safety.
- The meanings of "Marks" used here are as follows:

	Never do it under any circumstances.	 	Always do it according to the instruction.
---	--------------------------------------	---	--

- Beware of danger from a dropped tool or the like in installing the unit in an elevated position.
- When the air conditioning unit makes abnormal sounds in operation, consult with your dealer.



WARNING



- To disconnect the appliance from the mains supply this appliance must be connected to the mains by means of a circuit breaker or a switch (use a recognized 16A) with a contact separation of at least 3mm.
- The appliance shall be installed in accordance with national wiring regulations.
- This system should be applied to places as households, residences and the like. Application to inferior environment such as engineering shop could cause equipment malfunction.
- Ask your dealer or a specialized service provider to install the unit.
Improper installation work performed on the part of a user can result in a water leak, electric shock or fire.
- Carry out installation work properly according to this installation manual.
Improper installation work can result in a water leak, electric shock, or fire.
- Always turn off power before you work inside the unit such as for installation or servicing.
A failure to observe this instruction can result in an electric shock.
- Install the unit securely onto a structure that is strong enough to sustain its weight.
Insufficient strength or improper installation can cause a fall of the unit and resultant injury.
- Electrical installation work must be performed according to the installation manual as dedicated circuits exclusively for the air conditioning system in compliance with the applicable "Technical standards for electrical installation" and "Indoor wiring regulations."
A defect in power supply circuits such as insufficient capacity or improper installation can cause an electrical shock or fire.
- Always connect between indoor and outdoor units securely with specified cables. Never use an intermediate connection or stranded wire for this purpose.
Fasten cables securely so that the terminal block may not be subject to external force working through cables.
Improper connection or fastening can cause heat generation and a resultant fire.
- Neatly arrange the cables connecting between indoor and outdoor units so that they may not get loose, and put on the lid and/or service panel securely.
Improper installation can cause heat generation at terminal connections and a resultant fire or electric shock.
- Use only parts supplied with the unit and approved supply parts for installation work.
A failure to use genuine parts approved by the manufacturer may result in a fall of the unit, a water leak, a fire, an electric shock, a refrigerant leak, substandard performance or a control failure.
- If refrigerant gas leaks during installation work, ventilate the room.
Refrigerant gas, if it comes into contact with bare fire, can cause the generation of a toxic gas.
- Use pipes, flare nuts and tools specifically designed for R410A.
The diversion of existing materials (designed for R22) can result in a unit failure as well as a serious accident such as refrigeration cycle rupture or injury.
- In carrying out a pump-down process, stop the compressor before you detach the refrigerant pipe.
If you detach the pipe with the compressor running and the operation valves (liquid and gas sides) open, an abnormal pressure build-up will occur in the refrigeration cycle, which can result in pipe rupture or injury.
- In installing the unit, be sure to attach the refrigerant pipe before operating the compressor.
If you run the compressor without attaching the refrigerant pipe and with the operation valves (liquid and gas sides) open, you may incur frost bite or injury from an abrupt refrigerant outflow. An abnormal pressure build-up may also occur in the refrigeration cycle as a result of the inhalation of air, which can result in pipe rupture or injury.
- Tighten a flare nut with a torque wrench in a specified manner.
Over-tightening a flare nut can cause a refrigerant gas leak from breakage after years of operation and the generation of a toxic product, if refrigerant gas comes into contact with bare fire.
- In inserting the power cable plug, make sure that no anomalies such as dust deposits, socket clogging or wobble are found in both the plug and outlet and insert the plug fully to the roots of its blades.
Dust deposits, clogging or wobble can result in an electric shock or fire. If the outlet is loose, change it with a new one.
- Never open the operation valves (either liquid or gas side) until refrigerant pipe installation work, an air-tightness test and an air purge are completed.
A failure to observe this instruction can result in frost bite or injury from an abrupt refrigerant outflow. If refrigerant gas leaks during installation work, immediately stop pipe blazing and other work and ventilate the room.



- Do not run the drain piping directly into the sewer where a toxic gas such as sulfuric gas is generated.
This will pose a risk of a toxic gas flowing back into the room. This can also cause the corrosion of the indoor unit and a resultant unit failure or refrigerant leak.
- You must collect, bring back and shred or otherwise properly dispose of all packaging materials, expanded polystyrene, bands, vinyl bags and so on used for the transpiration of the indoor and outdoor units after installation work.
- In installing or transferring an air conditioning system, never allow air or other foreign matters than specified refrigerant (R410A) to get into the refrigerant cycle (piping).
If air or other foreign matters gets into the refrigerant cycle, an abnormal pressure build-up will occur, which can result in pipe rupture or injury.
- Never modify the power cord, introduce an intermediate connection or connect it in a daisy chain.
A failure to observe this instruction can result in a fire or electric shock from improper contact, improper insulation, excessive current beyond rating, etc.
- Never bundle, wind or modify the power cord. Do not step onto the power plug or otherwise deform it.
A failure to observe this instruction can result in heat generation or ignition.



- Ensure that the unit is properly grounded.
Do not connect the grounding wire to a gas pipe, water pipe, lightning rod, or telephone ground wire.
If a defect is in a ground, it will become a cause of an electric shock at the time of failure or a short circuit.



CAUTION



- Take sufficient care so that you may not incur injury from heat exchanger fins, pipe flares and screws during work.
- Install drain piping according to the installation manual to ensure good drainage, and give it heat insulation to prevent condensation.
Improper installation can result in a flood of water in the room and soaked household effects.
- When the unit is installed in a humid or damp room, the installation of an earth leakage breaker is essential.
A failure to install an earth leakage breaker can cause an electric shock.
- When the air conditioning system is installed in a room equipped with a ventilating fan and it is used (for a cooling or dehumidifying) simultaneously with the ventilating fan, the room may have a negative pressure relative to the exterior, which can cause a reverse flow of drainage. Be lake sure that the room has an opening that allows the inflow of as much air as is discharged by the ventilating fan. (For example, open the door a little.)
If a room has a negative air pressure relative to the exterior due to the effect of winds in a high-rise condominium building, etc., provide an adequate opening, such as a window, to the exterior.
- Secure a service space for inspection and maintenance as specified in the manual.
An insufficient service space can result in a fall from an elevated position, etc.
- When the outdoor unit is installed on a roof to provide permanent ladders and handrails along the path and fences or handrails surrounding the outdoor unit.
- Dress the refrigerant piping with a heat insulation material to prevent condensation.
Improper heat insulation given to refrigerant piping for leakage or dripping water soaking household effects.
- In removing packaging materials, take sufficient care as not to damage the contents or incur injury from such work.



- Do not install the unit in the place where a risk of inflammable gas leaks exists.
Should gas leak and gather around the unit, it can cause an explosion or fire.
- Do not touch the air intake and aluminum fins of the door unit.
You may incur injury if you touch them.
- Do not install the outdoor unit in a place where animals are likely to inhabit.
If they enter the unit and touch electrical parts inside, it may cause a unit failure or fire. Please ask the customer to keep the surroundings clear.
- Do not install the outdoor unit where its fan will be directly hit a plant etc.
Fan winds can affect adversely to the plant etc.
- Do not operate the outdoor unit with any article on it.
A failure to observe this instruction can result in a fall, damage or personal injury.

Notabilia as a unit designed for R410A

- Do not use any refrigerant other than R410A. R410A will rise to pressure about 1.6 times higher than that of a conventional refrigerant. A cylinder containing R410A has a pink indication mark on the top.
- A unit designed for R410A has adopted a different size indoor unit operation valve charge port and a different size check joint provided in the unit to prevent the charging of a wrong refrigerant by mistake. The processed dimension of the flared part of a refrigerant pipe and a flare nut's parallel side measurement have also been altered to raise strength against pressure. Accordingly, you are required to arrange dedicated R410A tools listed in the table on the right before installing or servicing this unit.
- Do not use a charge cylinder. The use of a charge cylinder will cause the refrigerant composition to change, which results in performance degradation.
- In charging refrigerant, always take it out from a cylinder in the liquid phase.
- All indoor units must be models designed exclusively for R410A. Check connectable indoor unit models in a catalog, etc. (A wrong indoor unit, if connected into the system, will impair proper system operation)

1. HAULAGE AND INSTALLATION (Take particular care in carrying in or moving the unit, and always perform such an operation with two or more persons.)

CAUTION When a unit is hoisted with slings for haulage, take into consideration the offset of its gravity center position. If not properly balanced, the unit can be thrown off-balance and fall.

1) Delivery

- Deliver the unit as close as possible to the installation site before removing it from the packaging.
- When you have to unpack the unit for a compelling reason before you haul it to the installation point, hoist the unit with nylon slings or ropes and protection pads so that you may not damage the unit.

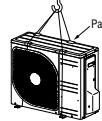

2) Portage

- The right hand side of the unit as viewed from the front (diffuser side) is heavier. A person carrying the right hand side must take heed of this fact. A person carrying the left hand side must hold with his right hand the handle provided on the front panel of the unit and with his left hand the corner column section.



3) Selection of installation location for the outdoor unit

Be sure to select a suitable installation place in consideration of following conditions.

- A place where it is horizontal, stable and can endure the unit weight and will not allow vibration transmittance of the unit.
- A place where it can be free from possibility of bothering neighbors due to noise or exhaust air from the unit.
- A place where the unit is not exposed to oil splashes.
- A place where it can be free from danger of flammable gas leakage.
- A place where drain water can be disposed without any trouble.
- A place where the unit will not be affected by heat radiation from other heat source.
- A place where snow will not accumulate.
- A place where the unit can be kept away 5m or more from TV set and/or radio receiver in order to avoid any radio or TV interference.
- A place where good air circulation can be secured, and enough service space can be secured for maintenance and service of the unit safely.
- A place where the unit will not be affected by electromagnetic waves and/or high-harmonic waves generated by other equipment.
- A place where chemical substances like sulfuric gas, chloric gas, acid and alkali (including ammonia), which can harm the unit, will not be generated and not remain.
- If a operation is conducted when the outdoor air temperature is -5 lower, the outdoor unit should be installed at a place where it is not influenced by natural wind.
- A place where strong wind will not blow against the outlet air blow of the unit.

4) Caution about selection of installation location

- (1) If the unit is installed in the area where the snow will accumulate, following measures are required. The bottom plate of unit and intake, outlet may be blocked by snow.

- ① Install the unit on the base so that the bottom is higher than snow cover surface.

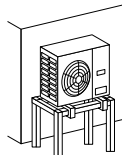

- ② Provide a snow hood to the outdoor unit on site. Regarding outline of a snow hood, refer to our technical manual.

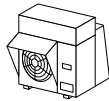

- ③ Install the unit under eaves or provide the roof on site.

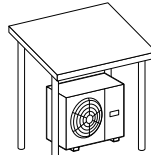

- Since drain water generated by defrost control may freeze, following measures are required.
- Don't execute drain piping work by using a drain elbow and drain grommets (optional parts). [Refer to Drain piping work.]
 - Recommend setting Defrost Control (SW3-1) and Snow Guard Fan Control (SW3-2). [Refer to Setting SW3-1, SW3-2.]

- (2) If the unit can be affected by strong wind, following measures are required. Strong wind can cause damage of fan (fan motor), or can cause performance degradation, or can trigger anomalous stop of the unit due to rising of high pressure.

1. Install the outlet air blow side of the unit to face a wall of building, or provide a fence or a windbreak screen.

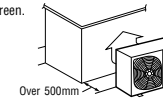

2. Install the outlet air blow side of the unit in a position perpendicular to the direction of wind.

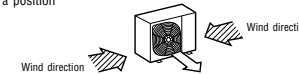

5) Installation space

- Walls surrounding the unit in the four sides are not acceptable.
- There must be a 1-meter or larger space in the above.
- When more than one unit are installed side by side, provide a 250mm or wider interval between them as a service space. In order to facilitate servicing of controllers, please provide a sufficient space between units so that their top plates can be removed easily.
- Where a danger of short-circuiting exists, install guide louvers.
- When more than one unit are installed, provide sufficient intake space consciously so that short-circuiting may not occur.
- Where piling snow can bury the outdoor unit, provide proper snow guards.

Size	Example installation	Model 40, 50, 60 (mm)			
		I	II	III	IV
L1	Open	280	280	180	
L2		100	75	Open	Open
L3		100	80	80	80
L4		250	Open	250	Open

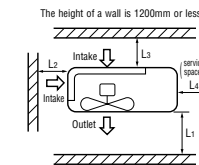

6) Installation

- ① Anchor bolt fixed position

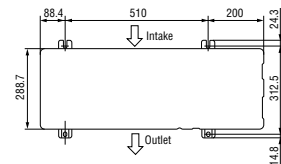

- ② Notabilia for installation

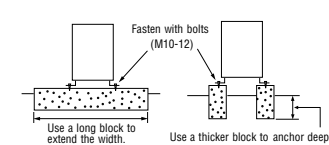

- In installing the unit, fix the unit's legs with bolts specified on the left.
 - The protrusion of an anchor bolt on the front side must be kept within 15 mm.
 - Securely install the unit so that it does not fall over during earthquakes or strong winds, etc.
 - Refer to the above illustrations for information regarding concrete foundations.
 - Install the unit in a level area. (With a gradient of 5 mm or less.)
- Improper installation can result in a compressor failure, broken piping within the unit and abnormal noise generation.

2. REFRIGERANT PIPING WORK

1) Restrictions on unit installation and use

- Check the following points in light of the indoor unit specifications and the installation site.
- Observe the following restrictions on unit installation and use. Improper installation can result in a compressor failure or performance degradation.

Restrictions		Dimensional restrictions	Marks appearing in the drawing on the right
Main pipe length		30m or less	L
Elevation difference between indoor and outdoor units	When the outdoor unit is positioned higher,	20m or less	H
	When the outdoor unit is positioned lower,	20m or less	H

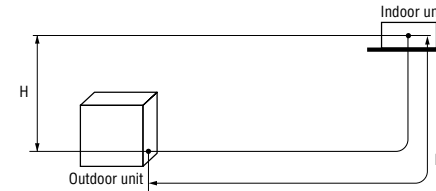

CAUTION ● The use restrictions appearing in the table above are applicable to the standard pipe size combinations shown in the table below. Where an existing pipe system is utilized, different one-way pipe length restrictions should apply depending on its pipe size. For more information, please see "5. UTILIZATION OF EXISTING PIPING."

2) Determination of pipe size

- Determine refrigerant pipe size pursuant to the following guidelines based on the indoor unit specifications.

	Model 40, 50, 60	
	Gas pipe	Liquid pipe
Outdoor unit connected	φ 12.7 Flare	φ 6.35 Flare
Refrigerant piping (branch pipe)L	φ 12.7	φ 6.35
Indoor unit connected	φ 12.7	φ 6.35

When pipe is brazing.

About brazing

Brazing must be performed under a nitrogen gas flow.

Without nitrogen gas, a large quantity of foreign matters (oxidized film) are created, causing a critical failure from capillary tube or expansion valve clogging.

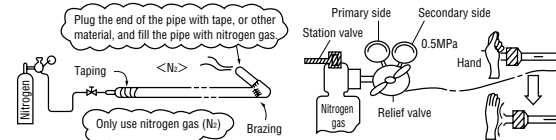

3) Refrigerant pipe wall thickness and material

- Select refrigerant pipes of the table shown on the right wall thickness and material as specified for each pipe size.

NOTE ● Select pipes having a wall thickness larger than the specified minimum pipe thickness.

Pipe diameter [mm]	6.35	12.7
Minimum pipe wall thickness [mm]	0.8	0.8
Pipe material*	O-type pipe	O-type pipe

*Phosphorus deoxidized seamless copper pipe ICS 23.040.15, ICS 77.150.30

4) On-site piping work

IMPORTANT Take care so that installed pipes may not touch components within a unit. If touching with an internal component, it will generate abnormal sounds and/or vibrations.

How to remove the side cover Please remove the screw of a side cover and remove to the front.

- Carry out the on site piping work with the operation valve fully closed.
- Give sufficient protection to a pipe end (compressed and blazed, or with an adhesive tape) so that water or foreign matters may not enter the piping.
- Bend a pipe to a radius as large as practical.(R100~R150) Do not bend a pipe repeatedly to correct its form.
- Flare connection is used between the unit and refrigerant pipe. Flare a pipe after engaging a flare nut onto it. Flare dimensions for R410A are different from those for conventional R407C. Although we recommend the use of flaring tools designed specifically for R410A, conventional flaring tools can also be used by adjusting the measurement of protrusion B with a protrusion control gauge.

- Tighten a flare joint securely with a double spanner.

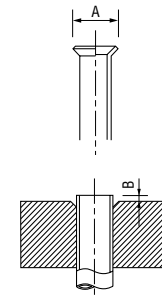
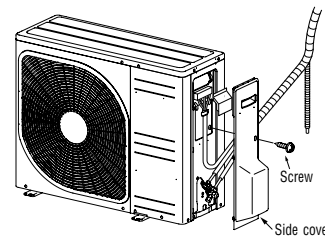

Flared pipe end : A (mm)

Copper pipe outer diameter	A	0
		-0.4
φ6.35		9.1
φ12.7		16.6

Copper pipe protrusion for flaring : B (mm)

Copper pipe outer diameter	In the case of a rigid (clutch) type	
	With an R410A tool	With a conventional tool
φ6.35		
φ12.7	0~0.5	1.0~1.5

CAUTION

Do not apply force beyond proper fastening torque in tightening the flare nut.

Fix both liquid and gas service valves at the valve main bodies as illustrated on the right, and then fasten them, applying appropriate fastening torque.

Operation valve size (mm)	Tightening torque (N-m)	Tightening angle (°)	Recommended length of a tool handle (mm)
φ6.35 (1/4")	14~18	45~60	150
φ12.7 (1/2")	49~61	30~45	250

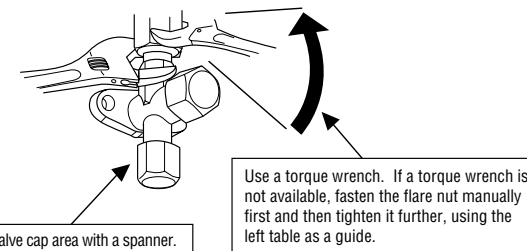

5) Air tightness test

- ① Although outdoor and indoor units themselves have been tested for air tightness at the factory, check the connecting pipes after the installation work for air tightness from the operation valve's check joint equipped on the outdoor unit side. While conducting a test, keep the operation valve shut all the time.
 - a) Raise the pressure to 0.5 MPa, and then stop. Leave it for five minutes to see if the pressure drops.
 - b) Then raise the pressure to 1.5 MPa, and stop. Leave it for five more minutes to see if the pressure drops.
 - c) Then raise the pressure to the specified level (4.15 MPa), and record the ambient temperature and the pressure.
 - d) If no pressure drop is observed with an installation pressurized to the specified level and left for about one day, it is acceptable. When the ambient Temperature fall 1°C, the pressure also fall approximately 0.01 MPa. The pressure, if changed, should be compensated for.
 - e) If a pressure drop is observed in checking e) and a) – d), a leak exists somewhere. Find a leak by applying bubble test liquid to welded parts and flare joints and repair it. After repair, conduct an air-tightness test again.
- ② In conducting an air-tightness test, use nitrogen gas and pressurize the system with nitrogen gas from the gas side. Do not use a medium other than nitrogen gas under any circumstances.

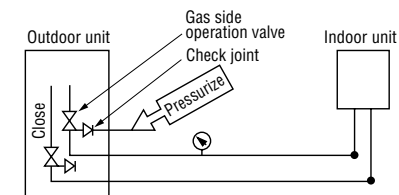

6) Evacuation

When the system has remaining moisture inside or a leaky point, the vacuum gauge indicator will rise. Check the system for a leaky point and then draw air to create a vacuum again.

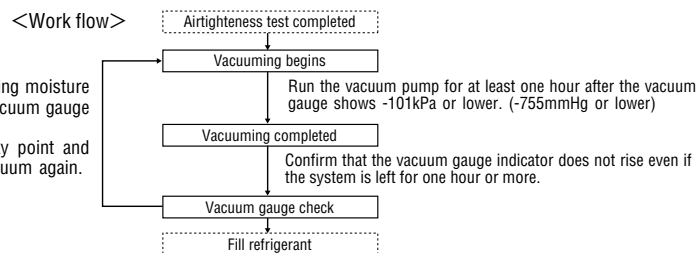

Pay attention to the following points in addition to the above for the R410A and compatible machines.

- To prevent a different oil from entering, assign dedicated tools, etc. to each refrigerant type. Under no circumstances must a gauge manifold and a charge hose in particular be shared with other refrigerant types (R22, R407C, etc.).
- Use a counterflow prevention adapter to prevent vacuum pump oil from entering the refrigerant system.

7) Additional refrigerant charge

(1) Calculate a required refrigerant charge volume from the following table.

	Additional charge volume (kg) per meter of refrigerant piping (liquid pipe φ6.35)	Refrigerant volume charged for shipment at the factory (kg)	Installation's pipe length (m) covered without additional refrigerant charge
Model 40, 50, 60	0.02	1.40	15

- This unit contains factory charged refrigerant covering 15m of refrigerant piping and additional refrigerant charge on the installation site is not required for an installation with up to 15m refrigerant piping. When refrigerant piping exceeds 15m, additionally charge an amount calculated from the pipe length and the above table for the portion in excess of 15m.
- If an existing pipe system is used, a required refrigerant charge volume will vary depending on the liquid pipe size. For further information, please see "5. UTILIZATION OF EXISTING PIPING."

Formula to calculate the volume of additional refrigerant required

$$\text{Additional charge volume (kg)} = \{ \text{Main length (m)} - \text{Factory charged volume 15 (m)} \} \times 0.02 \text{ (kg/m)}$$

*When an additional charge volume calculation result is negative, it is not necessary to charge refrigerant additionally.

- For an installation measuring 15 m or shorter in pipe length, please charge the refrigerant volume charged for shipment at the factory, when you recharge refrigerant after servicing etc.

(2) Charging refrigerant

- Since R410A refrigerant must be charged in the liquid phase, you should charge it, keeping the container cylinder upside down or using a refrigerant cylinder equipped with a siphon tube.
- Charge refrigerant always from the liquid side service port with the operation valve shut. When you find it difficult to charge a required amount, fully open the outdoor unit valves on both liquid and gas sides and charge from the gas (suction) side service port, while running the unit in the cooling mode. In doing so, care must be taken so that refrigerant may be discharged from the cylinder in the liquid phase all the time. When the unit is throttled down or a dedicated conversion tool to change liquid-phase refrigerant into mist is used to protect the compressor, however, adjust charge conditions so that refrigerant will gasify upon entering the unit.
- In charging refrigerant, always charge a calculated volume by using a scale to measure the charge volume.
- When refrigerant is charged with the unit being run, complete a charge operation within 30 minutes. Running the unit with an insufficient quantity of refrigerant for a long time can cause a compressor failure.

NOTE Put down the refrigerant volume calculated from the pipe length onto the caution label attached on the back side of the service panel.

8) Heating and condensation prevention

- (1) Dress refrigerant pipes (both gas and liquid pipes) for heat insulation and prevention of dew condensation.
 - Improper heat insulation/anti-dew dressing can result in a water leak or dripping causing damage to household effects, etc.
- (2) Use a heat insulating material that can withstand 120°C or a higher temperature. Poor heat insulating capacity can cause heat insulation problems or cable deterioration.
 - All gas pipes must be securely heat insulated in order to prevent damage from dripping water that comes from the condensation formed on them during a cooling operation or personal injury from burns because their surface can reach quite a high temperature due to discharged gas flowing inside during a heating operation.
 - Wrap indoor units' flare joints with heat insulating parts (pipe cover) for heat insulation (both gas and liquid pipes).
 - Give heat insulation to both gas and liquid side pipes. Bundle a heat insulating material and a pipe tightly together so that no gaps may be left between them and wrap them together with a connecting cable by a dressing tape.
 - **Both gas and liquid pipes need to be dressed with 20 mm or thicker heat insulation materials above the ceiling where relative humidity exceeds 70%.**

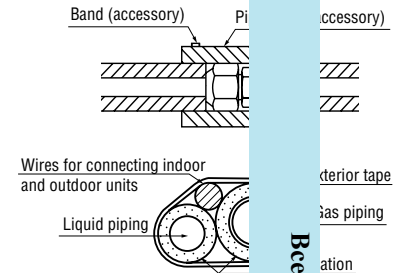

3. DRAIN PIPING WORK

- Execute drain piping by using a drain elbow and drain grommets supplied separately as optional parts, where water drained from the outdoor unit is a problem.

Where you are likely to have several days of sub-zero temperatures in a row, do not use a drain elbow and drain grommets. (There is a risk of drain water freezing inside and blocking the drain.)

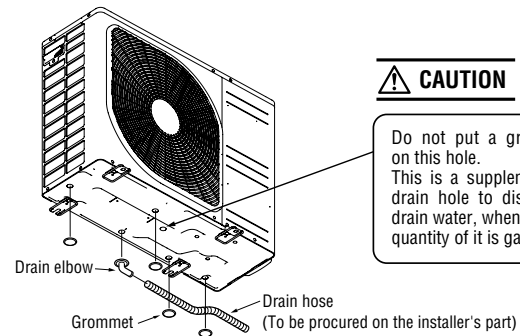

- When condensed water is led to a drain, etc., use a flat base (supplied as an optional part) or cork blocks.

4. ELECTRICAL WIRING WORK For details of electrical cabling, refer to the indoor unit installation manual.

Electrical installation work must be performed by an electrical installation service provider qualified by a power provider of the country. Electrical installation work must be executed according to the technical standards and other regulations applicable to electrical installations in the country.

- Do not use any supply cord lighter than one specified in parentheses for each type below.
 - braided cord (code designation 60245 IEC 51),
 - ordinary tough rubber sheathed cord (code designation 60245 IEC 53)
 - flat twin tinsel cord (code designation 60227 IEC 41);
 Use polychloroprene sheathed flexible cord (code designation 60245 IEC57) for supply cords of parts of appliances for outdoor use.
- Ground the unit. Do not connect the grounding wire to a gas pipe, water pipe, lightning rod or telephone grounding wire. If improperly grounded, an electric shock or malfunction may result.
- A grounding wire must be connected before connecting the power cable. Provide a grounding wire longer than the power cable.
- The installation of an impulse withstanding type earth leakage breaker is necessary. A failure to install an earth leakage breaker can result in an accident such as an electric shock or a fire.
- Do not turn on the power until the electrical work is completed.
- Do not use a condensive capacitor for power factor improvement under any circumstances. (It does not improve power factor, while it can cause an abnormal overheat accident)
- For power supply cables, use conduits.
- Do not lay electronic control cables (remote control and signaling wires) and other cables together outside the unit. Laying them together can result in the malfunctioning or a failure of the unit due to electric noises.
- Fasten cables so that they may not touch the piping, etc.
- When cables are connected, make sure that all electrical components within the electrical component box are free of loose connector coupling or terminal connection and then attach the cover securely. (Improper cover attachment can result in malfunctioning or a failure of the unit, if water penetrates into the box.)
- Always use a three-core cable for an indoor-outdoor connecting cable. Never use a shield cable.

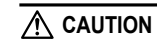

CAUTION

In case of faulty wiring connection, the indoor units tops, and then the run lamp turns on and the timer lamp blinks.

Use cables for interconnection wiring to avoid loosening of the wires. CENELEC code for cables Required field cables.

- H05 RNR3G1.5 (Example) or 245IEC57
- H Harmonized cable type
- 05 300/500 volts
- R Natural-and/or synth. rubber wire insulation
- N Polychloroprene rubber conductors insulation
- R Stranded core
- 4or5 Number of conductors
- G One conductor of the cable is the earth conductor (yellow/green)
- 1.5 Section of copper wire (mm²)

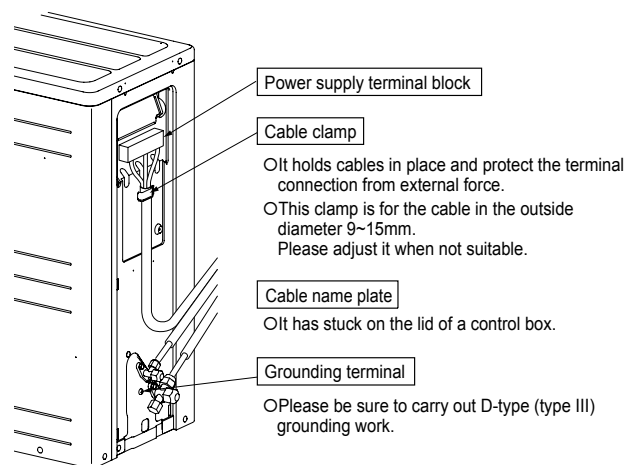

Power cable, indoor-outdoor connecting wires

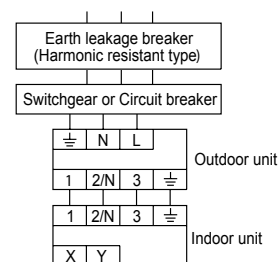

- Always perform grounding system installation work with the power cord unplugged.

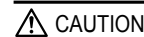

CAUTION Always use an earth leakage circuit breaker designed for inverter circuits to prevent a faulty operation.

Phase	Model	Earth leakage breaker	Switchgear or Circuit Breaker		Power source (minimum)	Interconnecting and grounding wires (minimum)
			Switch breaker	Over current protector rated capacity		
Single-phase	40	15A,30mA, 0.1sec or less	30A	16A	2.0mm ²	1.5mm ² ×4
	50					
	60					

- The specifications shown in the above table are for units without heaters. For units with heaters, refer to the installation instructions or the construction instructions of the indoor unit.
- Switchgear or Circuit breaker capacity which is calculated from MAX. over current should be chosen along the regulations in each country.
- The cable specifications are based on the assumption that a metal or plastic conduit is used with no more than three cables contained in a conduit and a voltage drop is 2%. For an installation falling outside of these conditions, please follow the internal cabling regulations. Adapt it to the regulation in effect in each country.

5. UTILIZATION OF EXISTING PIPING.

Check whether an existing pipe system is reusable or not by using the following flow chart.

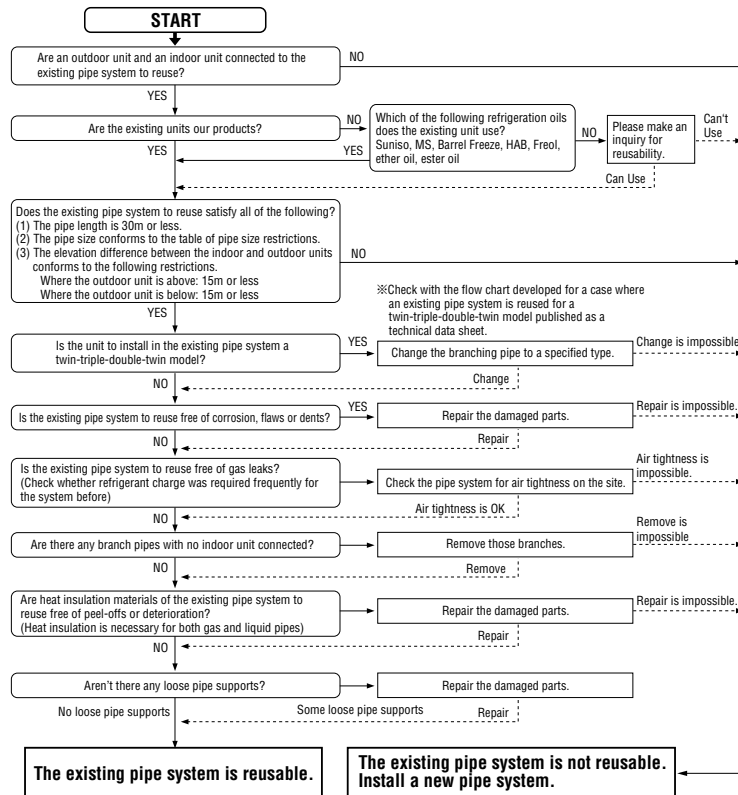

<Table of pipe size restrictions>

◎:Standard pipe size ○:Usable △:Restricted to shorter pipe length limits

Additional charge volume per meter of pipe		0.02kg/m	0.06kg/m
Pipe size	Liquid pipe	φ6.35	φ9.52
	Gas pipe	φ12.7	φ12.7
40	Usability	◎	△
	Maximum one-way pipe length	30	10
	Length covered without additional charge	15	5
50	Usability	◎	△
	Maximum one-way pipe length	30	10
	Length covered without additional charge	15	15
60	Usability	◎	△
	Maximum one-way pipe length	30	10
	Length covered without additional charge	15	5

- Please consult with our distributor in the area, if you need to recover refrigerant and charge it again.
- Any combinations of pipe sizes not listed in the table are not usable.

Formula to calculate additional charge volume

$$\text{Additional charge volume (kg)} = (\text{Main pipe length (m)} - \text{Length covered without additional charge shown in the table (m)}) \times \text{Additional charge volume per meter of pipe shown in the table (kg/m)}$$

※ If you obtain a negative figure as a result of calculation, no additional refrigerant needs to be charged.

Example When an 60 is installed in a 10m long existing pipe system (liquid φ9.52, gas φ12.7), the quantity of refrigerant to charge additionally should be (10m-5m) × 0.06kg/m = 0.3 kg.



WARNING <Where the existing unit can be run for a cooling operation.>

Carry out the following steps with the excising unit (in the order of (1), (2), (3) and (4))

- (1) Run the unit for 30 minutes for a cooling operation.
- (2) Stop the indoor fan and run the unit for 3 minutes for a cooling operation (returning liquid)
- (3) Close the liquid side operation valve of the outdoor unit and pump down (refrigerant recovery)
- (4) Blow with nitrogen gas. ※ If discolored refrigeration oil or any foreign matters is discharged by the blow, wash the pipe system or install a new pipe system.

- For the flare nut, do not use the old one, but use the one supplied with the outdoor unit. Process a flare to the dimensions specified for R410A.

<Where the existing unit cannot be run for a cooling operation.>

- Wash the pipe system or install a new pipe system.
- If you choose to wash the pipe system, please contact our distributor in the area.

INSTALLATION TEST CHECK POINTS

Check the following points again after completion of the installation, and before turning on the power. Conduct a test run again and ensure that the unit operates properly. Explain to the customer how to use the unit and how to take care of the unit following the instruction manual.

After installation

- | | |
|---|---|
| <input type="checkbox"/> Power cables and crossover wires are securely fixed to the terminal block. | <input type="checkbox"/> The pipe joints for indoor and outdoor pipes have been insulated. |
| <input type="checkbox"/> The power supply voltage is correct as the rating. | <input type="checkbox"/> The reverse flow check cap is attached. |
| <input type="checkbox"/> The drain hose is fixed securely. | <input type="checkbox"/> The cover of the pipe cover (A) faces downward to prevent rain from entering. |
| <input type="checkbox"/> Operational valve is fully open. | <input type="checkbox"/> Gaps are properly sealed between the pipe covers (A) (B) and the wall surface / pipes. |
| <input type="checkbox"/> No gas leaks from the joints of the operational valve. | |

1.6 Outline of operation control by microcomputer

1.6.1 Operation control function by remote controller

◆ Operation section

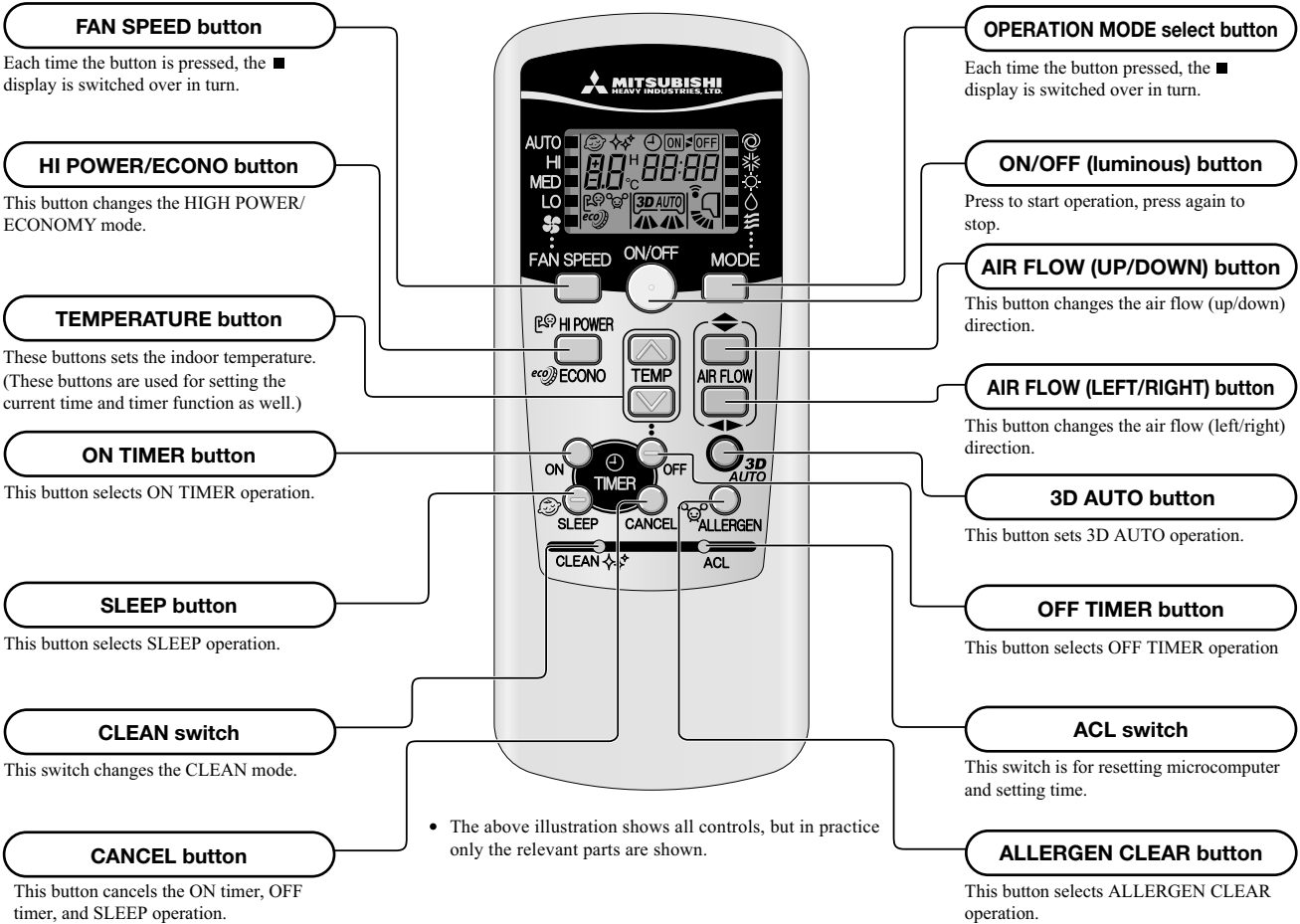

Unit indication section

Model All models

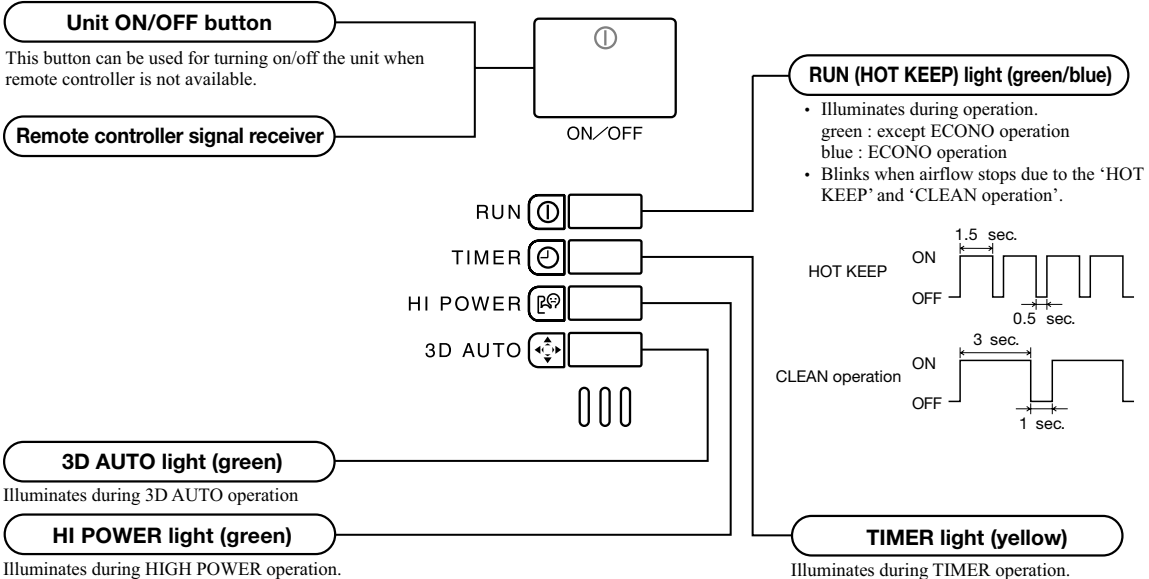

1.6.2 Unit ON/OFF button

When the remote controller batteries become weak, or if the remote controller is lost or malfunctioning, this button may be used to turn the unit on and off.

(1) Operation

Push the button once to place the unit in the automatic mode. Push it once more to turn the unit off.

(2) Details of operation

The unit will go into the automatic mode in which it automatically determines, from indoor temperature (as detected by sensor), whether to go into the cooling, thermal dry or heating modes.

Function operation mode	Indoor temperature setting	Fan speed	Flap/Louver	Timer Switch
Cooling	About 24°C	Auto	Auto	Continuous
Thermal dry	About 25°C			
Heating	About 26°C			

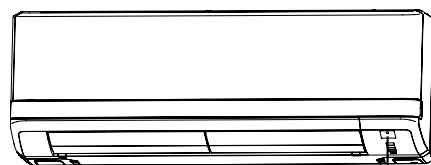

Unit ON/OFF button

1.6.3 Auto restart function

(1) Auto restart function records the operational status of the air-conditioner immediately prior to be switched off by a power cut, and then automatically resumes operations after the power has been restored.

(2) The following settings will be cancelled:

- (a) Timer settings
- (b) HIGH POWER operations

Notes (1) Auto restart function is set at on when the air-conditioner is shipped from the factory. Consult with your dealer if this function needs to be switched off.

(2) When power failure occurs, the timer setting is cancelled. Once power is resumed, reset the timer.

(3) If the jumper wire (J170) "AUTO RESTART" is cut, auto restart is disabled. (See the diagram at right)

Jumper wire (J170)

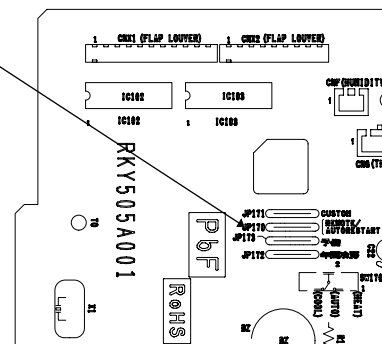

Jumper wire (J171)

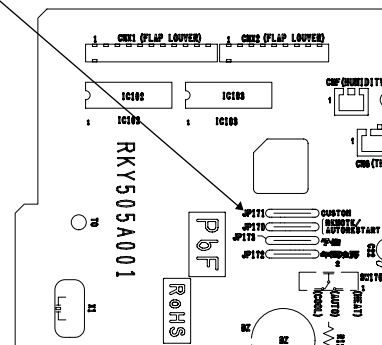

1.6.4 Custom cord switching procedure

If two wireless remote controller are installed in one room, in order to prevent wrong operation due to mixed signals, please modify the printed circuit board in the indoor unit's control box and the remote controller using the following procedure. Be sure to modify both boards. If only one board is modified, receiving (and operation) cannot be done.

(1) Modifying the indoor printed circuit board

Take out the printed circuit board from the control box and cut off jumper wire (J171) using wire cutters.

After cutting of the jumper wire, take measures to prevent contact with the other the lead wires, etc.

(2) Modifying the wireless remote controller

- (a) Remove the battery.
- (b) Cut the jumper wire shown in the figure at right.

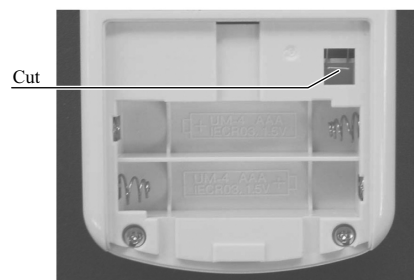

1.6.5 Flap and louver control

Control the flap and louver by AIRFLOW \blacklozenge (UP/DOWN) and $\blacktriangleleft\blacktriangleright$ (LEFT/RIGHT) button on the wireless remote controller.

(1) Flap

Each time when you press the AIRFLOW \blacklozenge (UP/DOWN) button the mode changes as follows.

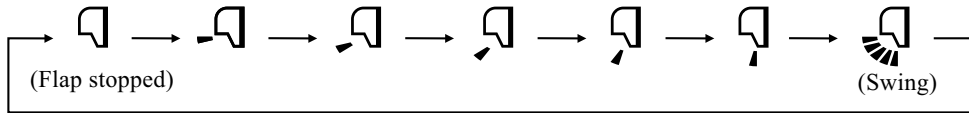

• Angle of Flap from Horizontal

Remote controller display					
COOL , DRY, FAN	Approx. 5°	Approx. 20°	Approx. 35°	Approx. 45°	Approx. 60°
HEAT	Approx. 20°	Approx. 35°	Approx. 45°	Approx. 60°	Approx. 75°

(2) Louver

Each time when you press the AIRFLOW $\blacktriangleleft\blacktriangleright$ (LEFT/RIGHT) button the mode changes as follows.

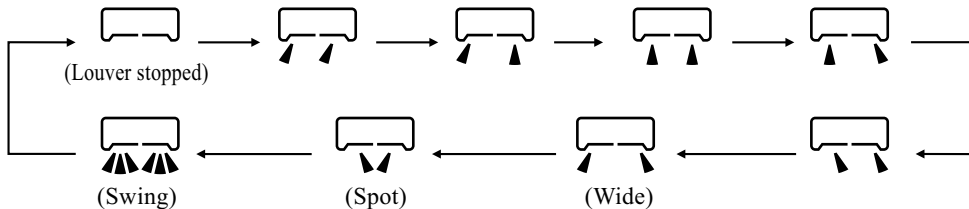

• Angle of Louver

Remote controller display					
Center installation	Left Approx. 50°	Left Approx. 20°	Center	Right Approx. 20°	Right Approx. 50°
Right end installation	Left Approx. 50°	Left Approx. 45°	Left Approx. 30°	Center	Right Approx. 20°
Left end installation	Left Approx. 20°	Center	Right Approx. 30°	Right Approx. 45°	Right Approx. 50°

(3) Swing

(a) Swing flap

Flap moves in upward and downward directions continuously.

\blacklozenge In HEAT operation \blacklozenge In COOL, DRY, FAN operation

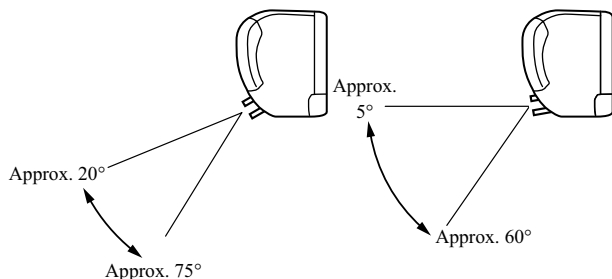

(b) Swing louver

Louver moves in left and right directions continuously.

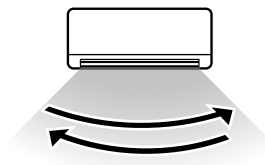

(4) Memory flap (Flap or Louver stopped)

When you press the AIRFLOW (UP/DOWN or LEFT/RIGHT) button once while the flap or louver is operating, it stops swinging at the position. Since this angle is memorized in the microcomputer, the flap or louver will automatically be set at this angle when the next operation is started.

(5) When not operating

The flap returns to the position of air flow directly below, when operation has stopped.

1.6.6 3D auto operation

Control the flap and louver by 3D AUTO button on the wireless remote controller.

Air flow selection and air flow direction are automatically controlled, allowing the entire indoor to efficiently conditioned.

(1) During Cooling and Heating (Including auto cooling and heating)

(a) Air flow selection is determined according to indoor temperature and setting temperature.

Operation mode	Air flow selection				
	AUTO		HI	MED	LO
At cooling	Indoor temp. – Setting temp. >5°C	Indoor temp. – Setting temp. ≤ 5°C	HI	MED	LO
	HIGH POWER	AUTO			
At heating	Setting temp. – Indoor temp. >5°C	Setting temp. – Indoor temp. ≤ 5°C	HI	MED	LO
	HIGH POWER	AUTO			

(b) Air flow direction is controlled according to the indoor temperature and setting temperature.

1) When 3D auto operation starts

	Cooling	Heating
Flap	Up/down Swing	
Louver	Wide (fixed)	Center (fixed)

2) When Indoor temp. – Setting temp. is ≤ 5°C during cooling and when Setting temp. – Indoor temp. is ≤ 5°C during heating, the system switches to the following air flow direction control. After the louver swings left and right symmetrically for 3 cycles, control is switched to the control in 3).

	Cooling	Heating
Flap	Horizontal blowing (Fixed)	Slant forwardl blowing (Fixed)
Louver	Left/right Swing	

3) After the flap swings for 5 cycles, control is switched to the control in 4).

	Cooling	Heating
Flap	Up/down Swing	
Louver	Center (Fixed)	

4) For 5 minutes, the following air flow direction control is carried out.

	Cooling	Heating
Flap	Horizontal blowing (Fixed)	Slant forwardl blowing (Fixed)
Louver	Wide (Fixed)	

5) After 5 minutes have passed, the air flow direction is determined according to the indoor temperature and setting temperature.

Operation mode	Air flow direction control		
At cooling	Indoor temp. – Setting temp. ≤ 2°C	2°C < Indoor temp. – Setting temp. ≤ 5°C	Indoor temp. – Setting temp. > 5°C
	The control in 4) continues.	Control returns to the control in 2).	Control returns to the control in 1).
At heating	Setting temp. – Indoor temp. ≤ 2°C	2°C < Setting temp. – Indoor temp. ≤ 5°C	Setting temp. – Indoor temp. > 5°C
	The control in 4) continues.	Control returns to the control in 2).	Control returns to the control in 1).

(2) During DRY Operation (including auto DRY operation)

Air flow selection	According to DRY operation.
Flap	Horizontal blowing (Fixed)
Louver	Wide (Fixed)

1.6.7 Timer operation

(1) Comfortable timer setting (ON timer)

If the timer is set at ON when the operation select switch is set at the cooling or heating, or the cooling or heating in auto mode operation is selected, the comfortable timer starts and determines the starting time of next operation based on the initial value of 15 minutes and the relationship between the indoor temperature at the setting time (temperature of room temperature sensor) and the setting temperature.

(2) Sleep timer operation

Pressing the SLEEP button causes the temperature to be controlled with respect to the set temperature.

(3) OFF timer operation

The Off timer can be set at a specific time (in 10-minute units) within a 24-hour period.

1.6.8 Installation location setting

When the indoor unit is installed at the end of a room, control the air flow direction so that it is not toward the side walls. If you set the remote controller installation position, keep it so that the air flow is within the range shown in the following figure.

(1) Setting

(a) If the air conditioning unit is running, press the ON/OFF button to stop.

The installation location setting cannot be made while the unit is running.

(b) Press the AIR FLOW $\blacktriangleup/\blacktriangledown$ (UP/DOWN) button and the AIRFLOW $\blacktriangleleft/\blacktriangleright$ (LEFT/RIGHT) button together for 5 seconds or more.

The installation location display illuminates.

(c) Setting the air-conditioning installation location.

Press the AIR FLOW $\blacktriangleleft/\blacktriangleright$ (LEFT/RIGHT) button and adjust to the desired location.

Each time the AIR FLOW $\blacktriangleleft/\blacktriangleright$ (LEFT/RIGHT) button is pressed, the indicator is switched in the order of:



(d) Press the ON/OFF button.

The air-conditioner's installation location is set.

Press within 60 seconds of setting the installation location (while the installation location setting display illuminates).

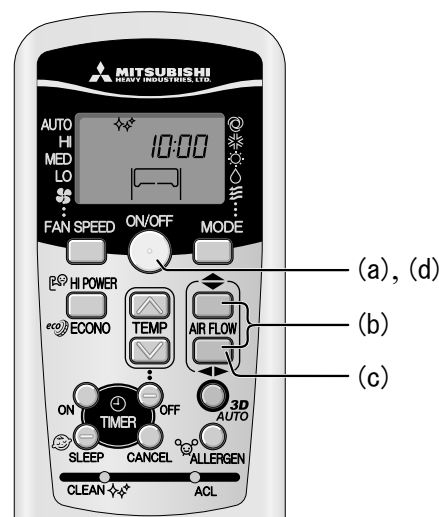
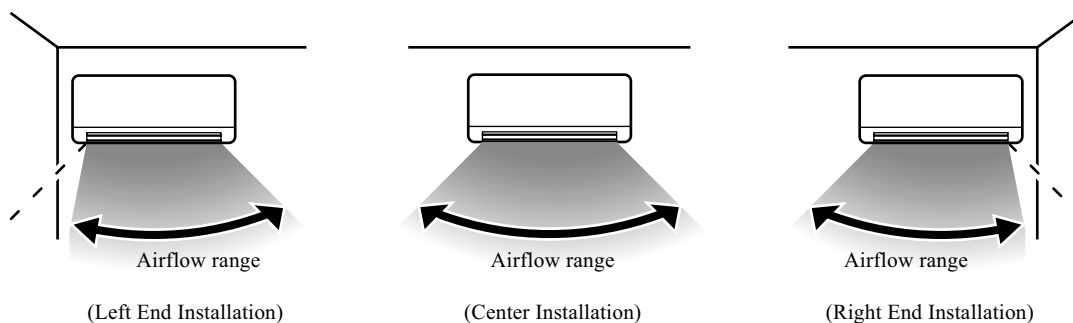

1.6.9 Outline of heating operation

(1) Operation of major functional components in heating mode

	Heating		
	Thermostat ON	Thermostat OFF	Failure
Compressor	ON	OFF	OFF
Indoor fan motor	ON	ON(HOT KEEP)	OFF
Outdoor fan motor	ON	OFF (few minutes ON)	OFF
4-way valve	ON	ON	OFF (3 minutes ON)

(2) Details of control at each operation mode (pattern)

(a) Fuzzy operation

Deviation between the indoor temperature setting correction temperature and the return air temperature is calculated in accordance with the fuzzy rule, and used for control of the air capacity and the compressor speed.

Fan speed	Model	SRK20ZIX-S	SRK25ZIX-S	SRK35ZIX-S	SRK50ZIX-S	SRK60ZIX-S
	Auto		30~94rps	30~102rps	30~115rps	12~106rps
HI		30~94rps	30~102rps	30~115rps	12~106rps	12~120rps
MED		30~66rps	30~72rps	30~76rps	12~74rps	12~90rps
LO		30~40rps	30~42rps	30~46rps	12~42rps	12~58rps

When the defrosting, protection device, etc. is actuated, operation is performed in the corresponding mode.

(b) Hot keep operation

If the hot keep operation is selected during the heating operation, the indoor blower is controlled based on the temperature of the indoor heat exchanger (Th2) to prevent blowing of cool wind.

(3) Defrosting operation

(a) Starting conditions (Defrosting operation can be started only when all of the following conditions are met.)

1) After start of heating operation

When it elapsed 45 (model 50, 60 : 35) minutes. (Accumulated compressor operation time)

2) After end of defrosting operation

When it elapsed 45 (model 50, 60 : 35) minutes. (Accumulated compressor operation time)

3) Outdoor heat exchanger sensor (TH1) temperature

When the temperature has been below -5°C for 3 minutes continuously.

4) The difference between the outdoor air sensor temperature and the outdoor heat exchanger sensor temperature

- The outdoor air temperature $\geq 0^{\circ}\text{C}$ (model 50, 60 : $\geq -2^{\circ}\text{C}$) : 7°C or higher
- $-15^{\circ}\text{C} \leq$ The outdoor air temperature $< 0^{\circ}\text{C}$ (model 50, 60 : $< -2^{\circ}\text{C}$) : $4/15 \times$ The outdoor air temperature + 7°C or higher
- The outdoor air temperature $< -15^{\circ}\text{C}$: -5°C or higher

5) During continuous compressor operation

In addition, when the speed command from the indoor controller of the indoor unit during heating operation has counted 0 rps 10 times or more and all conditions of 1), 2), 3) and 5) above and the outdoor air temperature is 3°C or less are satisfied (note that when the temperature for outdoor heat exchanger sensor (TH1) is -5°C or less: 62 rps or more, -4°C or less: less than 62 rps), defrost operation is started.

(b) Ending conditions (Operation returns to the heating cycle when either one of the following is met.)

- 1) Outdoor heat exchanger sensor (TH1) temperature: 13°C (model 50, 60 : 10°C) or higher
- 2) Continued operation time of defrosting \rightarrow For more than 15 min.

1.6.10 Outline of cooling operation

(1) Operation of major functional components in Cooling mode

	Cooling		
	Thermostat ON	Thermostat OFF	Failure
Compressor	ON	OFF	OFF
Indoor fan motor	ON	ON	OFF
Outdoor fan motor	ON	OFF (few minutes ON)	OFF (few minutes ON)
4-way valve	OFF	OFF	OFF

(2) Detail of control in each mode (Pattern)

(a) Fuzzy operation

During the fuzzy operation, the air flow and the compressor speed are controlled by calculating the difference between the indoor temperature setting correction temperature and the return air temperature.

Model	SRK20ZIX-S	SRK25ZIX-S	SRK35ZIX-S	SRK50ZIX-S	SRK60ZIX-S
Fan speed					
Auto	20~65rps	20~74rps	20~86rps	12~86rps	12~110rps
HI	20~65rps	20~74rps	20~86rps	12~86rps	12~110rps
MED	20~44rps	20~55rps	20~58rps	12~62rps	12~86rps
LO	20~30rps	20~34rps	20~38rps	12~34rps	12~48rps

1.6.11 Outline of automatic operation

(1) Determination of operation mode

The unit checks the indoor temperature and the outdoor air temperature, determines the operation mode, and then begins in the automatic operation.

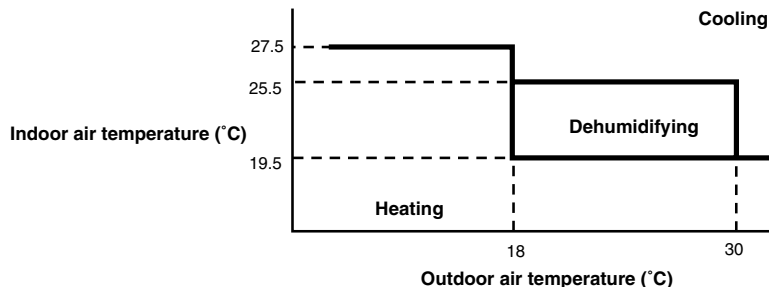

- The unit checks the temperature every hour after the start of operation and, if the result of check is not same as the previous operation mode, changes the operation mode.
- When the unit is started again within one hour after the stop of automatic operation or when the automatic operation is selected during heating, cooling or dehumidifying operation, the unit is operated in the previous operation mode.
- Setting temperature can be adjusted within the following range. There is the relationship as shown below between the signals of the wireless remote controller and the setting temperature.

		Signals of wireless remote controller (Display)												
		-6	-5	-4	-3	-2	-1	±0	+1	+2	+3	+4	+5	+6
Setting temperature	Cooling	18	19	20	21	22	23	24	25	26	27	28	29	30
	Dehumidifying	19	20	21	22	23	24	25	26	27	28	29	30	31
	Heating	20	21	22	23	24	25	26	27	28	29	30	31	32

Unit : °C

1.6.12 Protective control function

(1) Frost prevention control (During cooling or dehumidifying)

(a) Operating conditions

- Indoor heat exchanger temperature (Th2) is lower than 5°C.
- 5 minutes after reaching the compressor command speed except 0 rps.

(b) Detail of anti-frost operation

Indoor heat exchanger temperature	5°C or lower	2.5°C or lower
Lower limit of compressor command speed	22 rps (model 50, 60 : 25 rps)	0 rps
Indoor fan	Depends on operation mode	Protects the fan tap just before frost prevention control
Outdoor fan	Depends on command speed	Depends on stop mode
4-way valve	OFF	

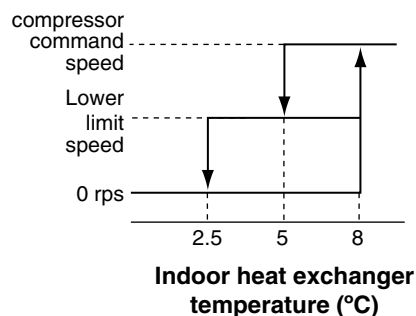

- Notes
- When the indoor heat exchanger temperature is in the range of 2.5~5°C, the speed is reduced by 4 rps at each 20 seconds.
 - When the temperature is lower than 2.5°C, the compressor is stopped.
 - When the indoor heat exchanger temperature is in the range of 5~8°C, the compressor command speed is been maintained.

(c) Reset conditions: When either of the following condition is satisfied.

- The indoor heat exchanger temperature (Th2) is 8°C or higher.
- The compressor command speed is 0 rps.

(2) Cooling overload protective control

(a) Operating conditions: When the outdoor air temperature (TH2) has become continuously for 30 seconds at 41°C or more, or 47°C or more (Models 50, 60: 41°C or more) with the compressor running, the lower limit speed of compressor is brought up.

Item	Model		SRK50, 60ZIX-S
	SRK20~35ZIX-S	SRK50, 60ZIX-S	
Outdoor air temperature	41°C or more	47°C or more	41°C or more
Lower limit speed	30 rps	40 rps	30 rps

(b) Detail of operation

- The outdoor fan is stepped up by 3 speed step. (Upper limit 7th (model 50, 60 : 8th) speed.)
- The lower limit of compressor command speed is set to 30 or 40 (SRK50, 60 : 30) rps and even if the calculated result becomes lower than that after fuzzy calculation, the speed is kept to 30 or 40 (SRK50, 60 : 30) rps. However, when the thermo becomes OFF, the speed is reduced to 0 rps.

(c) Reset conditions: When either of the following condition is satisfied.

- The outdoor air temperature is lower than 40°C or 46°C.
- The compressor command speed is 0 rps.

(3) Cooling high pressure control

(a) Purpose: Prevents anomalous high pressure operation during cooling.

(b) Detector: Outdoor heat exchanger sensor (TH1)

(c) Detail of operation:

(Example) Fuzzy

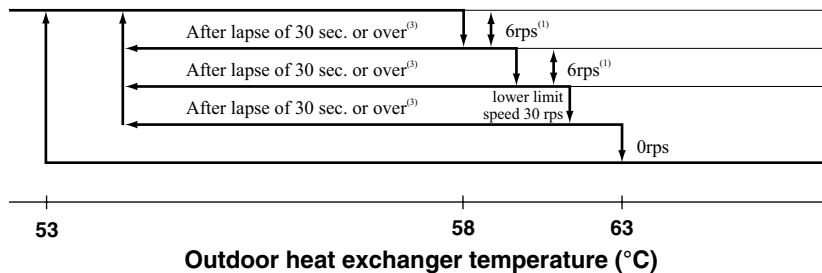

- Notes
- When the outdoor heat exchanger temperature is in the range of 58~63°C, the speed is reduced by 6 rps at each 30 seconds.
 - When the temperature is 63°C or higher, the compressor is stopped.
 - When the outdoor heat exchanger temperature is in the range of 53~58°C, if the compressor command speed is been maintained and the operation has continued for more than 30 seconds at the same speed, it returns to the normal cooling operation.

(4) Cooling low outdoor temperature protective control

(a) Operating conditions: When the outdoor air temperature (TH2) is 22°C or lower continues for 20 seconds while the compressor command speed is other than 0 rps.

(b) Detail of operation:

- 1) The lower limit of the compressor command speed is set to 44 (30) rps and even if the speed becomes lower than 44 (30) rps, the speed is kept to 44 (30) rps. However, when the thermo becomes OFF, the speed is reduced to 0 rps.
- 2) The upper limit of the compressor command speed is set to 50 (60) rps and even if the calculated result becomes higher than that after fuzzy calculation, the speed is kept to 50 (60) rps.

Note (1) Values in () are for outdoor air temperature is 22°C or 25°C

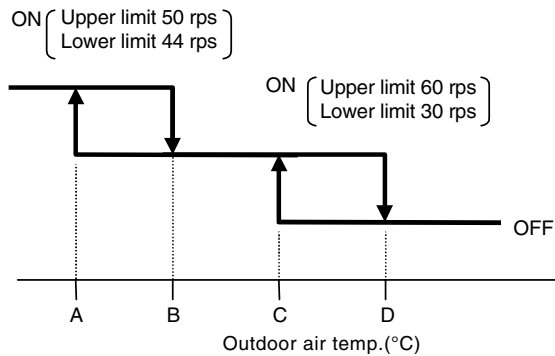

● Values of A, B, C, D

	Outdoor air temp. (°C)			
	A	B	C	D
First time	0	3	22	25
Since the seconds times	7	10	25	28

(c) Reset conditions: When either of the following condition is satisfied

- 1) The outdoor air temperature (TH2) is D °C or higher.
- 2) The compressor command speed is 0 rps.

(5) Heating high pressure control

(a) Purpose: Prevents anomalous high pressure operation during heating.

(b) Detector: Indoor heat exchanger sensor (Th2)

(c) Detail of operation:

(Example) Fuzzy

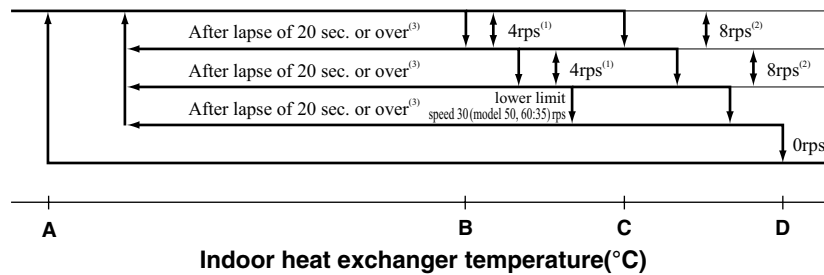

- Notes (1) When the indoor heat exchanger temperature is in the range of B~C °C, the speed is reduced by 4 rps at each 20 seconds.
 (2) When the indoor heat exchanger temperature is in the range of C~D °C, the speed is reduced by 8 rps at each 20 seconds. When the temperature is D °C or higher continues for 1 minute, the compressor is stopped.
 (3) When the indoor heat exchanger temperature is in the range of A~B °C, if the compressor command speed is been maintained and the operation has continued for more than 20 seconds at the same speed, it returns to the normal heating operation.
 (4) Indoor blower retains the fan tap when it enters in the high pressure control. Outdoor blower is operated in accordance with the speed.

● **Temperature list**

Model : 20~35

Unit : °C

	A	B	C	D
RPSmin < 50	48	53	55	58
50 ≤ RPSmin < 104	48.5	56	58	61
104 ≤ RPSmin	42.1	44	47.3	61

Model : 50, 60

Unit : °C

	A	B	C	D
RPSmin < 88	48.5	56	58	61
88 ≤ RPSmin < 108	44	51.5	53.5	56.5
108 ≤ RPSmin	39	46.5	48.5	51.5

Note (1) RPSmin: The lower one between the outdoor speed and the compressor command speed

(6) Heating overload protective control

(a) **Operating conditions:** When the outdoor air temperature (TH2) is 22°C (model 50, 60 : 17°C) or higher continues for 30 seconds while the compressor command speed other than 0 rps.

(b) **Detail of operation:**

- 1) Taking the upper limit of compressor command speed range at 60 rps (model 50, 60 : 50 rps), if the output speed obtained with the fuzzy calculation exceeds the upper limit, the upper limit value is maintained.
- 2) The lower limit of compressor command speed is set to 40 rps (model 50, 60 : 35 rps) and even if the calculated result becomes lower than that after fuzzy calculation, the speed is kept to 40 rps (model 50, 60 : 35 rps). However, when the thermo becomes OFF, the speed is reduced to 0 rps.
- 3) Inching prevention control is activated and inching prevention control is carried out with the minimum speed set at 40 rps (model 50, 60 : 35 rps).
- 4) The outdoor fan is set on 2nd speed.
- 5) The indoor fan is stepped up by 1 speed step. (Upper limit 8th speed)

(c) **Reset conditions:** The outdoor air temperature (TH2) is lower than 21°C (model 50, 60 : 16°C).

(7) Heating low outdoor temperature protective control

• Model 20~35

(a) **Operating conditions:** When the outdoor air temperature (TH2) is lower than -10°C or higher continues for 30 seconds while the compressor command speed is other than 0 rps.

(b) **Detail of operation:** The lower limit compressor command speed is change as shown in the figure below.

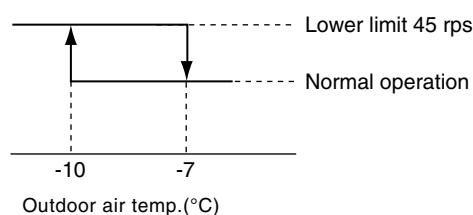

(c) **Reset conditions:** When either of the following condition is satisfied.

- 1) The outdoor air temperature (TH2) becomes -7°C.
- 2) The compressor command speed is 0 rps.

• Model 50, 60

(a) **Operating conditions:** When the outdoor air temperature (TH2) is lower than -4°C or 13°C or higher continues for 30 seconds while the compressor command speed is other than 0 rps.

(b) **Detail of operation:** The lower limit compressor command speed is change as shown in the figure below.

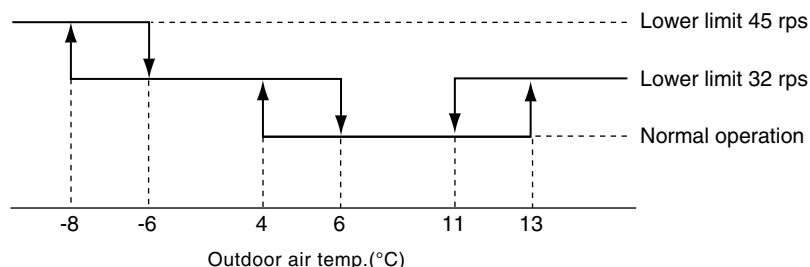

(c) **Reset conditions:** When either of the following condition is satisfied.

- 1) The outdoor air temperature (TH2) becomes 6°C ~ 11°C.
- 2) The compressor command speed is 0 rps.

(8) Compressor overheat protection

(a) **Purpose:** It is designed to prevent deterioration of oil, burnout of motor coil and other trouble resulting from the compressor overheat.

(b) Detail of operation

1) Speeds are controlled with temperature detected by the sensor mounted on the discharge pipe.

(Example) Fuzzy

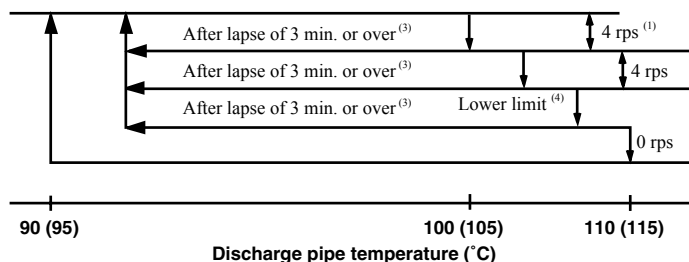

• Figures in () are for model 50, 60.

- Notes (1) When the discharge pipe temperature is in the range of 100~110°C (model 50, 60 : 105~115°C), the speed is reduced by 4 rps.
 (2) When the discharge pipe temperature is raised and continues operation for 20 seconds without changing, then the speed is reduced again by 4 rps.
 (3) If the discharge pipe temperature is in the range of 90~100°C (model 50, 60 : 95~105°C) even when the compressor command speed is maintained for 3 minutes when the temperature is in the range of 90~100°C (model 50, 60 : 95~105°C), the speed is raised by 1 rps and kept at that speed for 3 minutes. This process is repeated until the command speed is reached.
 (4) Lower limit speed

Model	Item	Cooling	Heating
		20~35	20 rps
Lower Limit Speed		50, 60	25 rps 32 rps

2) If the temperature of 110°C (model 50, 60 : 115°C) is detected by the sensor on the discharge pipe, then the compressor will stop immediately.

When the discharge pipe temperature drops and the time delay of 3 minutes is over, the unit starts again within 1 hour but there is no start at the third time.

(9) Current safe

(a) **Purpose:** Current is controlled not to exceed the upper limit of the setting operation current.

(b) **Detail of operation:** Input current to the converter is monitored with the current sensor fixed on the printed circuit board of the outdoor unit and, if the operation current value reaches the limiting current value, the compressor command speed is reduced.

If the mechanism is actuated when the compressor command speed is less than 30 rps, the compressor is stopped immediately. Operation starts again after a delay time of 3 minutes.

(10) Current cut

(a) **Purpose:** Inverter is protected from overcurrent.

(b) **Detail of operation:** Output current from the inverter is monitored with a shunt resistor and, if the current exceeds the setting value, the compressor is stopped immediately. Operation starts again after a delay time of 3 minutes.

(11) Outdoor unit failure

This is a function for determining when there is trouble with the outdoor unit during air conditioning.

The compressor is stopped if any one of the following in item (a), (b) is satisfied. Once the unit is stopped by this function, it is not restarted.

- (a) When the input current is measured at 1 A or less for 3 continuous minutes or more.
 (b) If the outdoor unit sends a 0 rps signal to the indoor unit 3 times or more within 20 minutes of the power being turned on.

(12) Indoor fan motor protection

When the air conditioner is operating and the indoor fan motor is turned ON, if the indoor fan motor has operated at 300 rpm or under for more than 30 seconds, the unit enters first in the stop mode and then stops the entire system.

(13) Serial signal transmission error protection

(a) Purpose: Prevents malfunction resulting from error on the indoor ↔ outdoor signals.

(b) Detail of operation: If the compressor is operating and a serial signal cannot be received from the indoor control with outdoor control having serial signals continues for 7 minute and 35 seconds, the compressor is stopped.

After the compressor has been stopped, it will be restarted after the compressor start delay if a serial signal can be received again from the indoor control.

(14) Rotor lock

If the motor for the compressor does not turn after it has been started, it is determined that a compressor lock has occurred and the compressor is stopped.

(15) Outdoor fan motor protection

If the outdoor fan motor has operated at 75 rpm or under for more than 30 seconds, the compressor and fan motor are stopped.

(16) Outdoor fan control at low outdoor temperature

◆ **Cooling**

(a) Operating conditions: When the outdoor air temperature (TH2) is 22°C or lower continues for 30 seconds while the compressor command speed is other than 0 rps.

(b) Detail of operation: After the outdoor fan operates at A speed for 60 seconds; the corresponding outdoor heat exchanger temperature shall implement the following controls.

● Value of A

	Outdoor fan
Outdoor temperature > 10°C	2nd speed
Outdoor temperature ≤ 10°C	1st speed

1) Outdoor heat exchanger temperature ≤ 21°C

After the outdoor fan speed drops (down) to 1 speed for 60 seconds; if the outdoor heat exchanger temperature is lower than 21°C, gradually reduce the outdoor fan speed by 1 speed. (Lower limit 1st speed)

2) 21°C < Outdoor heat exchanger temperature ≤ 38°C

After the outdoor fan speed maintains at A speed for 20 seconds; if the outdoor heat exchanger temperature is 21°C~38°C, maintain outdoor fan speed.

3) Outdoor heat exchanger temperature > 38°C

After the outdoor fan speed rises (up) to 1 speed for 60 seconds; if the outdoor heat exchanger temperature is higher than 38°C, gradually increase outdoor fan speed by 1 speed. (Upper limit 3rd speed)

(c) Reset conditions: When either of the following conditions is satisfied

1) The outdoor air temperature (TH2) is 25°C or higher.

2) The compressor command speed is 0 rps.

◆ **Heating**

(a) Operating conditions: When the outdoor air temperature (TH2) is 4°C or lower continues for 30 seconds while the compressor command speed is other than 0 rps.

(b) Detail of operation: The outdoor fan is stepped up by 2 speed step at each 20 seconds. (Upper limit 8th speed)

(c) Reset conditions: When either of the following conditions is satisfied

1) The outdoor air temperature (TH2) is 6°C or higher.

2) The compressor command speed is 0 rps.

2. FLOOR STANDING TYPE(SRF)

CONTENTS

2.1 Electrical wiring	46
2.2 Piping system	48
2.3 Noise level	49
2.4 Sensible heat capacity	52
2.5 Application data	53
2.5.1 Installation of indoor unit	53
2.5.2 Installation of outdoor unit	57
2.6 Outline of operation control by microcomputer	58

■ How to read the model name

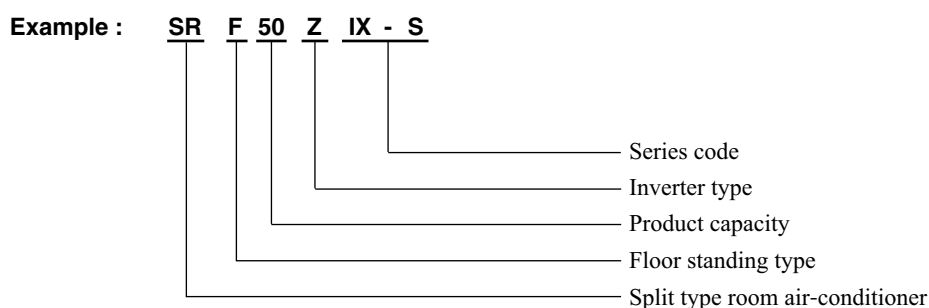

2.1 Electrical wiring

(1) Indoor unit

Models SRF25ZIX-S, 35ZIX-S, 50ZIX-S

Всe каталоги и инструкции здесь: <http://splitoff.ru/ehh-doc.html>

Item	Description
CNE-CN2	Connector
FM ₁	Fan motor
SM _{1,2}	Flap motor
DM ₁	Damper motor
DM ₂	Damper arm motor
Th ₁	Room temp. sensor
Th _{2,1,2}	Heat exch. sensor
Th ₃	Humidity sensor
DS	Diode stack
F	Fuse
T	Terminal block
Va	Varistor

Color Marks	
Mark	Color
BK	Black
BL	Blue
RD	Red
WH	White
Y	Yellow
Y/G	Yellow/Green

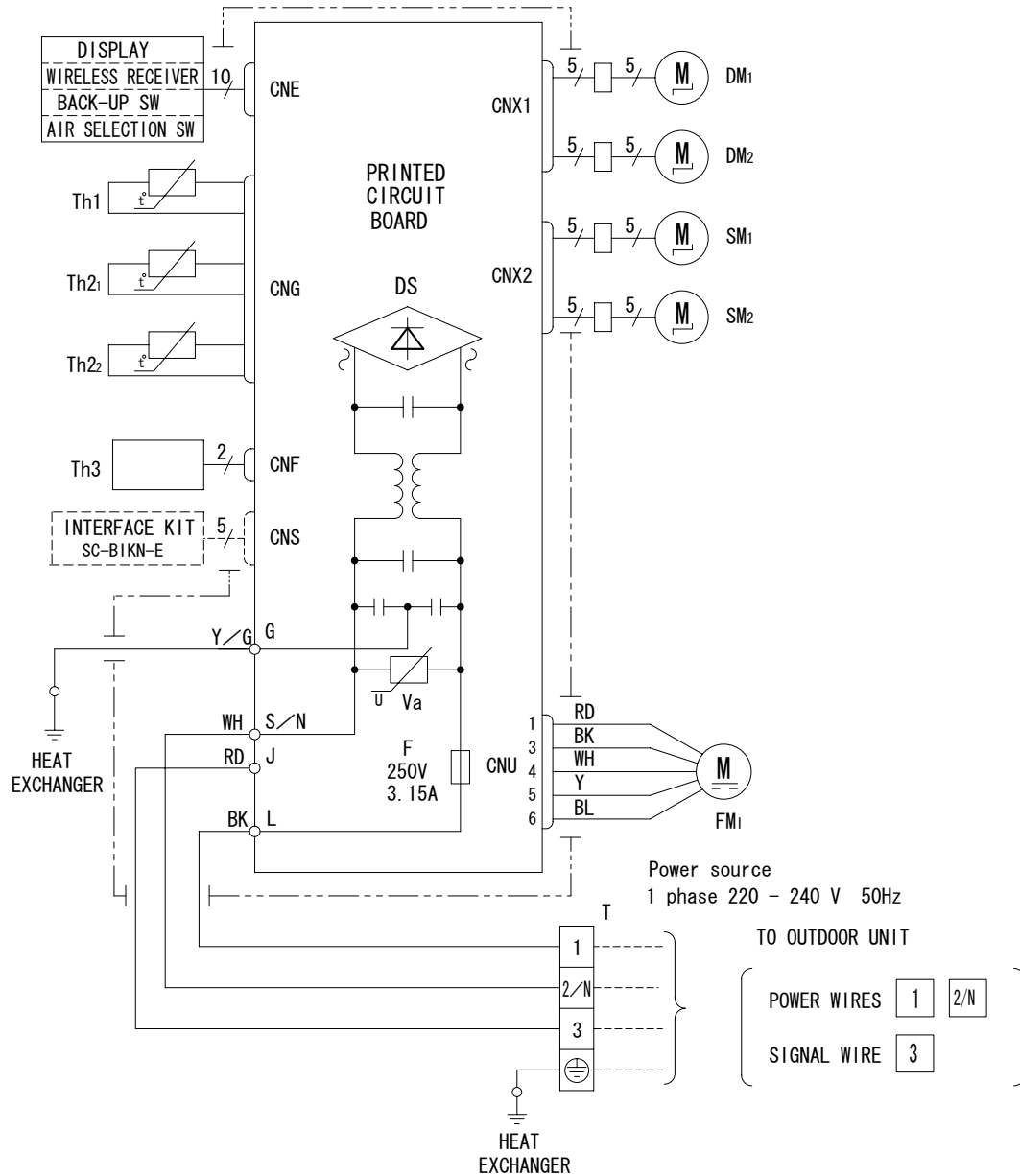

RWB000Z050

(2) Outdoor unit

Models SRC25ZIX-S, 35ZIX-S

Refer to page 4.

Model SRC50ZIX-S

Все каталоги и инструкции здесь: <http://splitoff.ru/tehn-doc.html>

2.2 Piping system

Model SRF25ZIX-S, 35ZIX-S

Все каталоги и инструкции здесь: <http://splitoff.ru/tehn-doc.html>

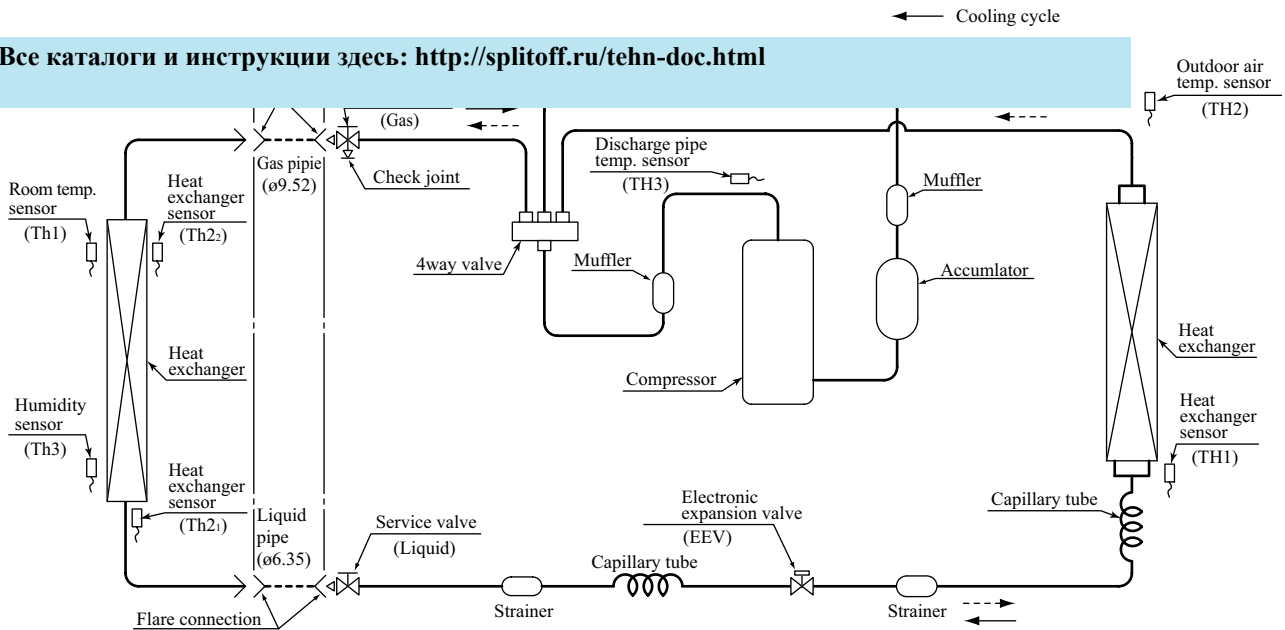

Model SRF50ZIX-S

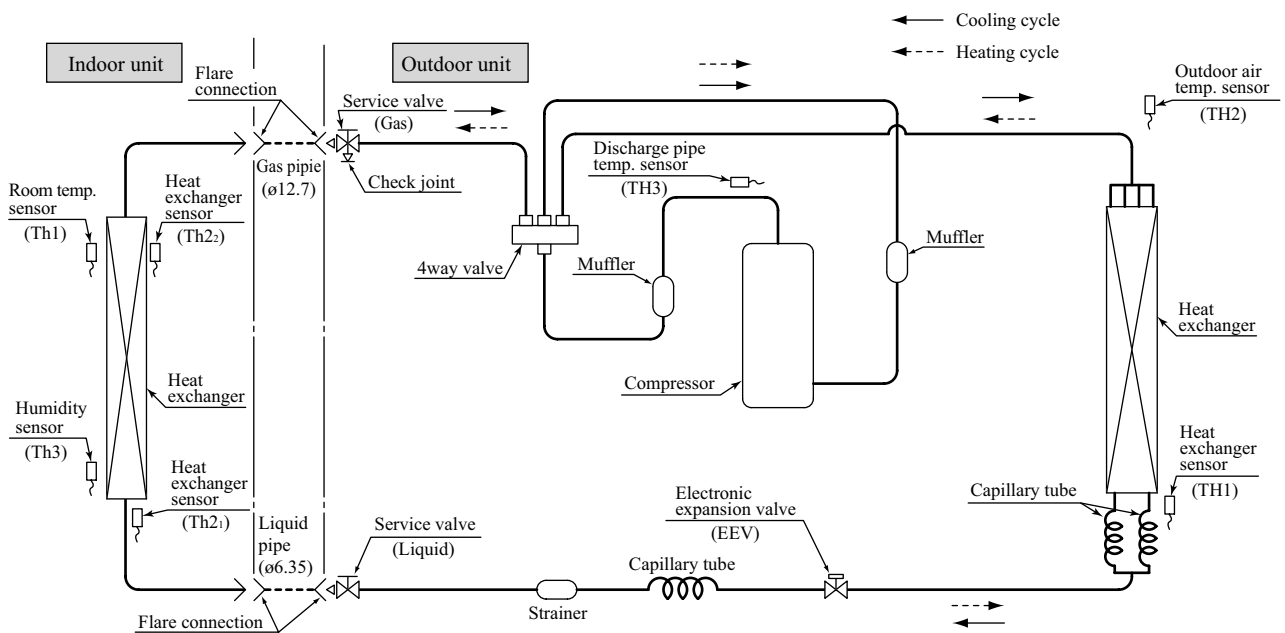

2.3 Noise level

Model SRF25ZIX-S

Condition ISO-T1, JIS C9612

(Indoor Unit)

Все каталоги и инструкции здесь: <http://splitoff.ru/tehn-doc.html>

Noise Level	Cooling	36 dB(A)
	Heating	38 dB(A)

× Cooling, ○ — Heating

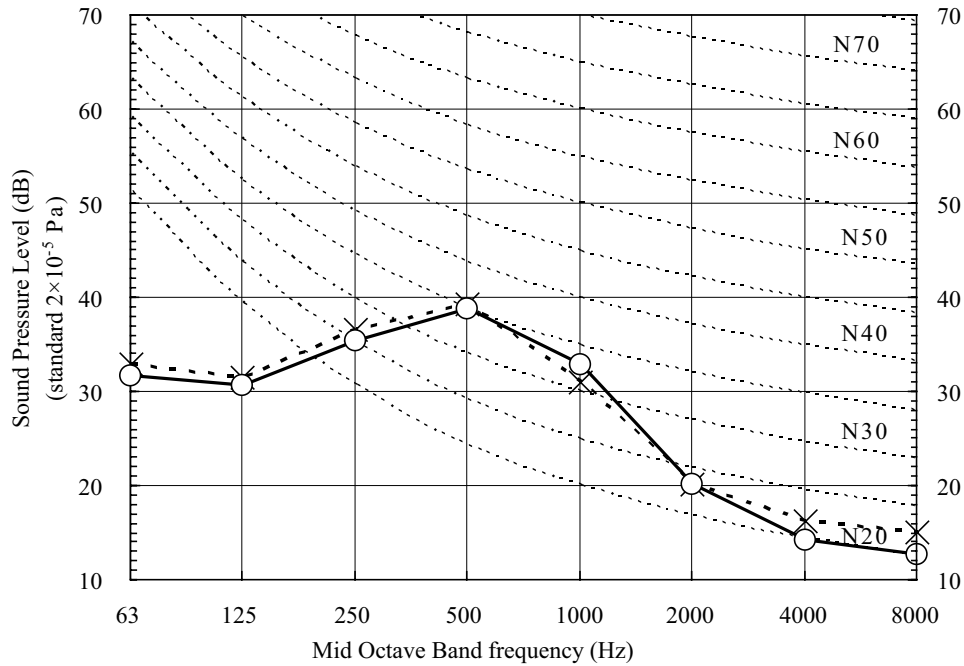

(Outdoor Unit)

Model	SRC25ZIX-S	
Noise Level	Cooling	47 dB(A)
	Heating	47 dB(A)

× Cooling, ○ — Heating

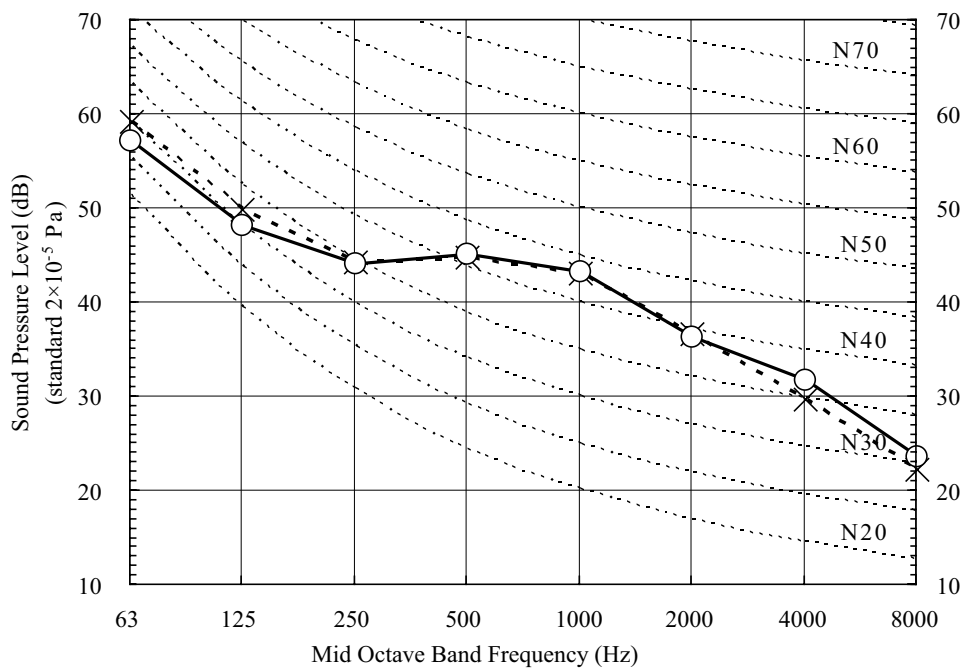

Model SRF35ZIX-S

Condition ISO-T1, JIS C9612

(Indoor Unit)

Model	SRF35ZIX-S	
Noise Level	Cooling	30 dB(A)

Все каталоги и инструкции здесь: <http://splitoff.ru/tehn-doc.html>

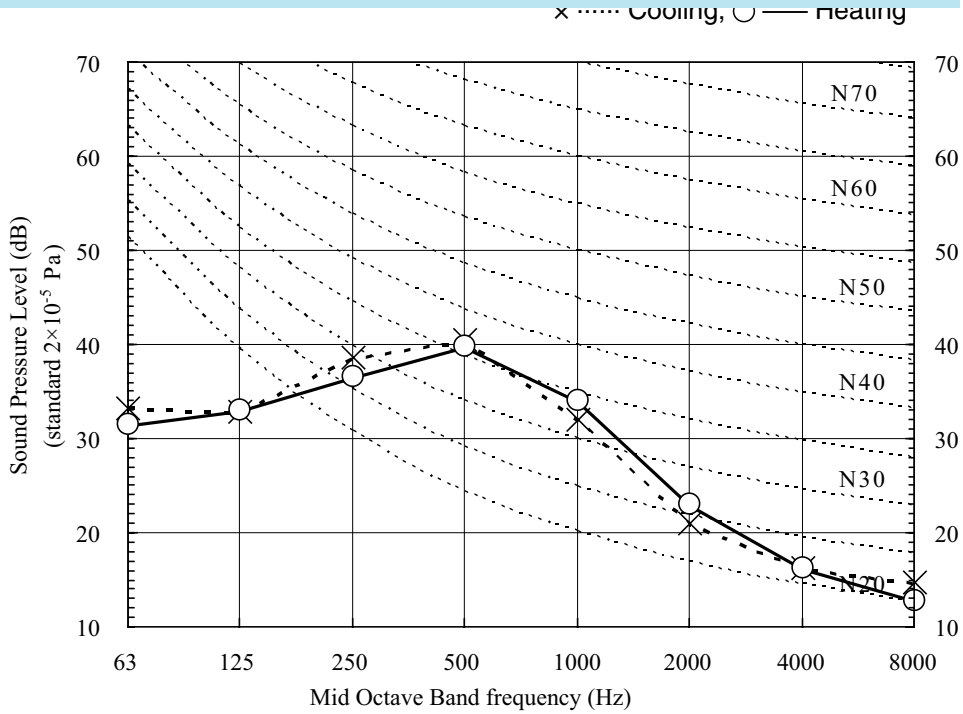

(Outdoor Unit)

Model	SRC35ZIX-S	
Noise Level	Cooling	50 dB(A)
	Heating	50 dB(A)

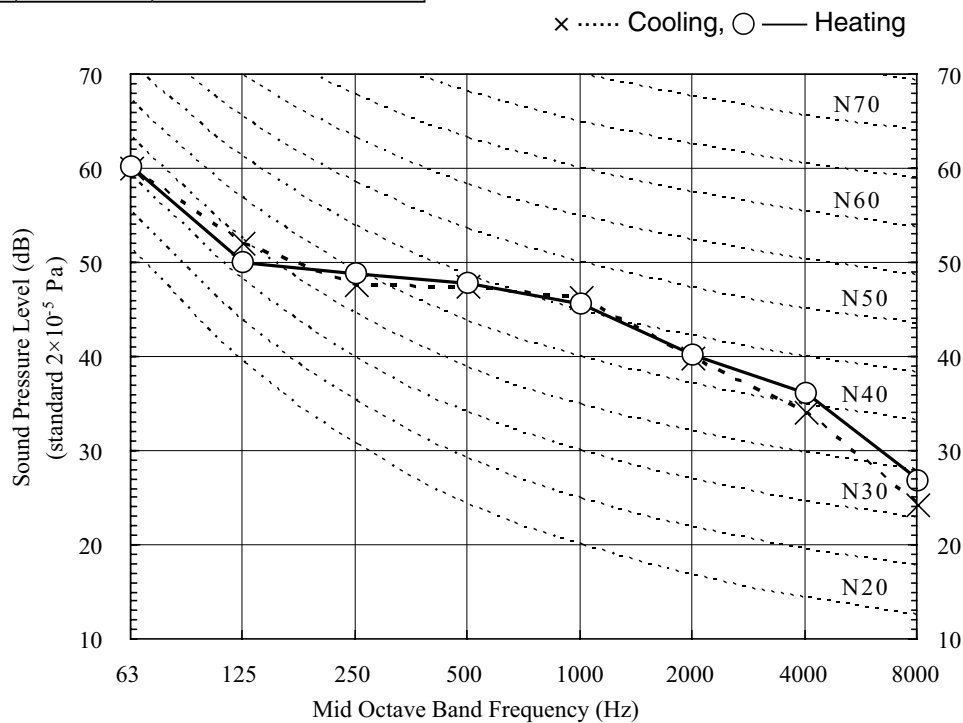

Model SRF50ZIX-S

Condition ISO-T1, JIS C9612

(Indoor Unit)

Model	SRF50ZIX-S	
Noise Level	Cooling	50 dB(A)

Все каталоги и инструкции здесь: <http://splitoff.ru/tehn-doc.html>

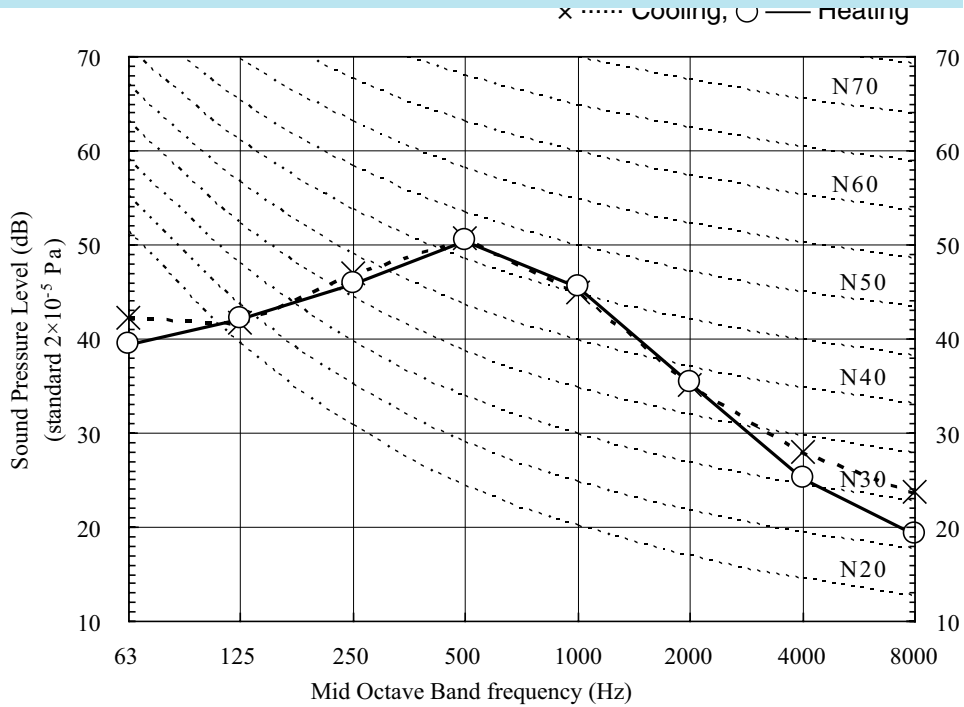

(Outdoor Unit)

Model	SRC50ZIX-S	
Noise Level	Cooling	48 dB(A)
	Heating	48 dB(A)

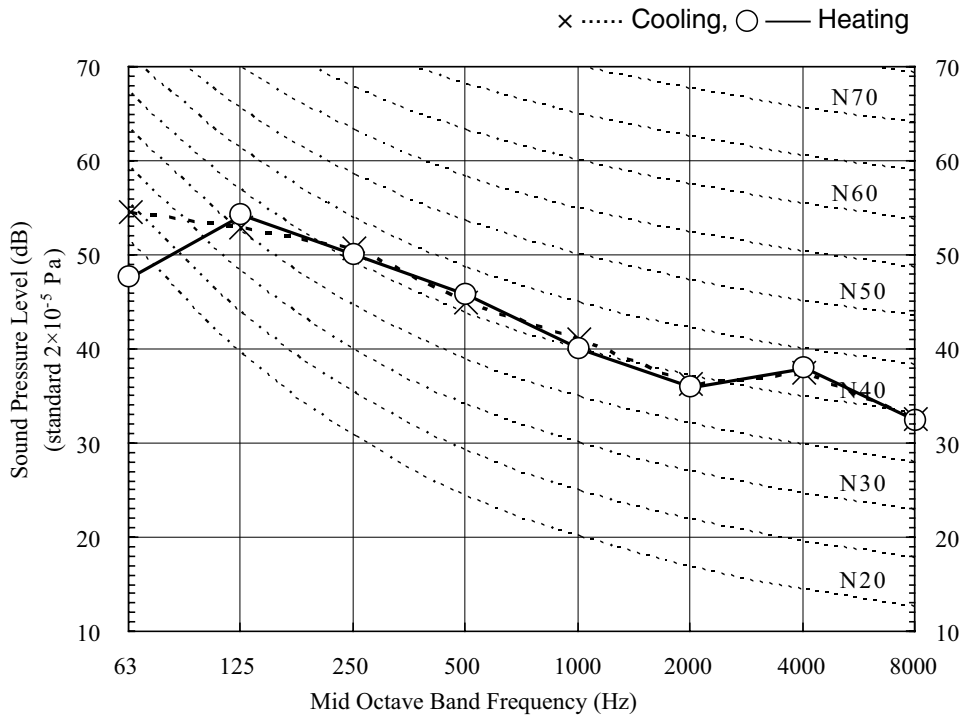

2.4 Sensible heat capacity

Model SRF25ZIX-S

Cool Mode

Air flow	Outdoor air temp.	Indoor air temp													
		21°CDB		23°CDB		26°CDB		27°CDB		28°CDB		31°CDB		33°CDB	
		TC	SHC	TC	SHC	TC	SHC	TC	SHC	TC	SHC	TC	SHC	TC	SHC
Hi 9.0 (m³/min)	10	2.82	2.39	2.95	2.35	3.06	2.46	3.11	2.43	3.16	2.40	3.26	2.50	3.34	2.44
	12	2.77	2.37	2.90	2.33	3.01	2.45	3.07	2.42	3.12	2.39	3.22	2.49	3.31	2.43
	14	2.71	2.34	2.85	2.30	2.97	2.43	3.03	2.40	3.08	2.38	3.18	2.48	3.28	2.42
	16	2.66	2.31	2.80	2.28	2.92	2.41	2.98	2.39	3.04	2.36	3.15	2.47	3.24	2.40
	18	2.60	2.29	2.74	2.26	2.88	2.39	2.94	2.37	2.99	2.34	3.11	2.45	3.20	2.39
	20	2.55	2.26	2.68	2.23	2.83	2.37	2.89	2.35	2.95	2.32	3.07	2.43	3.17	2.38
	22	2.49	2.24	2.63	2.21	2.78	2.35	2.84	2.33	2.90	2.31	3.02	2.42	3.13	2.37
	24	2.43	2.21	2.57	2.18	2.72	2.33	2.80	2.31	2.85	2.29	2.98	2.41	3.08	2.35
	26	2.37	2.18	2.51	2.16	2.67	2.31	2.74	2.29	2.80	2.27	2.93	2.39	3.04	2.34
	28	2.31	2.15	2.44	2.13	2.61	2.28	2.69	2.27	2.75	2.25	2.89	2.38	3.00	2.33
	30	2.24	2.12	2.38	2.11	2.56	2.25	2.64	2.25	2.70	2.22	2.84	2.36	2.95	2.31
	32	2.18	2.09	2.31	2.08	2.50	2.23	2.58	2.22	2.64	2.20	2.79	2.34	2.90	2.29
	34	2.11	2.06	2.25	2.05	2.44	2.21	2.53	2.20	2.59	2.18	2.74	2.32	2.85	2.28
	35	2.08	2.05	2.21	2.03	2.41	2.19	2.50	2.19	2.56	2.17	2.71	2.31	2.83	2.27
	36	2.04	2.03	2.18	2.02	2.38	2.18	2.47	2.18	2.53	2.16	2.69	2.31	2.80	2.27
	38	1.97	1.97	2.11	1.99	2.32	2.16	2.41	2.16	2.47	2.14	2.63	2.29	2.75	2.25
39	1.94	1.94	2.07	1.98	2.28	2.15	2.38	2.15	2.44	2.13	2.61	2.28	2.72	2.24	

Heat Mode

Air flow	outdoor	indoor air temp				
		16°CDB	18°CDB	20°CDB	22°CDB	24°CDB
Hi 10.5 (m³/min)	-10°CWB	2.37	2.33	2.29	2.24	1.91
	-5°CWB	2.56	2.53	2.48	2.45	2.19
	0°CWB	2.69	2.65	2.60	2.57	2.53
	5°CWB	3.42	3.38	3.37	3.30	3.25
	6°CWB	3.48	3.44	3.40	3.36	3.32
	10°CWB	3.70	3.66	3.64	3.59	3.55
	15°CWB	4.02	3.99	3.96	3.92	3.88
20°CWB	4.32	4.29	4.27	4.22	4.19	

Все каталоги и инструкции здесь: <http://splitoff.ru/tehn-doc.html>

Model SRF35ZIX-S

Cool Mode

Air flow	Outdoor air temp.	Indoor air temp													
		14°CWB		16°CWB		18°CWB		19°CWB		20°CWB		22°CWB		24°CWB	
		TC	SHC	TC	SHC	TC	SHC	TC	SHC	TC	SHC	TC	SHC	TC	SHC
Hi 9.2 (m³/min)	10	3.94	3.01	4.13	2.96	4.28	3.06	4.35	3.01	4.43	2.97	4.56	3.04	4.68	2.95
	12	3.87	2.97	4.06	2.92	4.22	3.03	4.29	2.99	4.37	2.95	4.51	3.02	4.63	2.93
	14	3.80	2.94	3.99	2.89	4.16	3.00	4.24	2.96	4.31	2.93	4.46	3.01	4.59	2.92
	16	3.72	2.90	3.91	2.86	4.09	2.97	4.18	2.94	4.25	2.90	4.40	2.99	4.54	2.90
	18	3.65	2.85	3.84	2.81	4.03	2.94	4.11	2.91	4.19	2.87	4.35	2.97	4.49	2.88
	20	3.57	2.81	3.76	2.78	3.96	2.91	4.05	2.88	4.13	2.85	4.29	2.95	4.43	2.87
	22	3.49	2.77	3.68	2.74	3.89	2.88	3.98	2.86	4.06	2.82	4.23	2.92	4.38	2.85
	24	3.40	2.73	3.59	2.70	3.81	2.85	3.91	2.82	3.99	2.79	4.17	2.90	4.32	2.83
	26	3.32	2.69	3.51	2.66	3.74	2.81	3.84	2.79	3.92	2.77	4.11	2.88	4.26	2.81
	28	3.23	2.65	3.42	2.62	3.66	2.78	3.77	2.77	3.85	2.74	4.04	2.86	4.20	2.78
	30	3.14	2.60	3.33	2.58	3.58	2.74	3.70	2.74	3.78	2.71	3.98	2.83	4.13	2.76
	32	3.05	2.56	3.24	2.54	3.50	2.71	3.62	2.70	3.70	2.67	3.91	2.80	4.06	2.74
	34	2.95	2.51	3.14	2.50	3.41	2.68	3.54	2.67	3.62	2.65	3.84	2.78	4.00	2.72
	35	2.91	2.49	3.10	2.47	3.37	2.66	3.50	2.65	3.58	2.63	3.80	2.77	3.96	2.71
	36	2.86	2.47	3.05	2.45	3.33	2.64	3.46	2.64	3.54	2.61	3.76	2.75	3.92	2.70
	38	2.76	2.42	2.95	2.41	3.24	2.60	3.38	2.60	3.46	2.58	3.69	2.72	3.85	2.67
39	2.71	2.39	2.90	2.39	3.20	2.58	3.33	2.59	3.42	2.56	3.65	2.71	3.81	2.66	

Heat Mode

Air flow	outdoor air temp.	indoor air temp				
		16°CDB	18°CDB	20°CDB	22°CDB	24°CDB
Hi 12.0 (m³/min)	-15°CWB	2.77	2.71	2.65	2.59	2.53
	-10°CWB	3.13	3.08	3.04	2.96	2.90
	-5°CWB	3.39	3.34	3.28	3.24	3.19
	0°CWB	3.56	3.51	3.44	3.40	3.35
	5°CWB	4.53	4.48	4.46	4.37	4.30
	6°CWB	4.61	4.55	4.50	4.44	4.39
	10°CWB	4.89	4.85	4.82	4.75	4.70
15°CWB	5.33	5.28	5.24	5.18	5.14	
20°CWB	5.72	5.68	5.65	5.59	5.54	

Model SRF50ZIX-S

Cool Mode

Air flow	Outdoor air temp.	Indoor air temp													
		21°CDB		23°CDB		26°CDB		27°CDB		28°CDB		31°CDB		33°CDB	
		TC	SHC	TC	SHC	TC	SHC	TC	SHC	TC	SHC	TC	SHC	TC	SHC
Hi 13.5 (m³/min)	10	5.63	4.14	5.90	4.07	6.11	4.18	6.22	4.12	6.32	4.06	6.51	4.13	6.69	3.98
	12	5.53	4.09	5.80	4.02	6.03	4.13	6.14	4.08	6.25	4.02	6.44	4.09	6.62	3.96
	14	5.43	4.03	5.70	3.96	5.94	4.09	6.05	4.04	6.16	3.99	6.37	4.06	6.55	3.93
	16	5.32	3.97	5.59	3.91	5.85	4.04	5.96	4.00	6.08	3.94	6.29	4.03	6.48	3.91
	18	5.21	3.91	5.48	3.86	5.75	4.00	5.88	3.96	5.99	3.91	6.21	4.00	6.41	3.89
	20	5.10	3.85	5.37	3.80	5.65	3.95	5.78	3.92	5.90	3.87	6.13	3.97	6.33	3.86
	22	4.98	3.78	5.25	3.74	5.55	3.91	5.69	3.87	5.80	3.83	6.05	3.94	6.25	3.83
	24	4.86	3.72	5.14	3.68	5.45	3.86	5.59	3.83	5.71	3.79	5.96	3.91	6.17	3.80
	26	4.74	3.66	5.01	3.62	5.34	3.81	5.49	3.78	5.61	3.74	5.87	3.87	6.08	3.77
	28	4.61	3.60	4.89	3.56	5.23	3.76	5.39	3.74	5.50	3.70	5.78	3.84	5.99	3.74
	30	4.49	3.53	4.76	3.50	5.11	3.71	5.28	3.69	5.40	3.65	5.68	3.80	5.90	3.70
	32	4.35	3.46	4.63	3.44	5.00	3.66	5.17	3.65	5.29	3.61	5.58	3.76	5.81	3.67
	34	4.22	3.40	4.49	3.37	4.88	3.60	5.06	3.59	5.18	3.56	5.48	3.72	5.71	3.64
	35	4.15	3.36	4.42	3.34	4.82	3.58	5.00	3.57	5.12	3.54	5.43	3.70	5.66	3.62
	36	4.08	3.33	4.35	3.31	4.76	3.55	4.94	3.55	5.06	3.51	5.37	3.68	5.61	3.60
	38	3.94	3.26	4.21	3.24	4.63	3.49	4.82	3.50	4.94	3.47	5.27	3.64	5.50	3.56
39	3.87	3.22	4.14	3.21	4.57	3.47	4.76	3.47	4.88	3.44	5.21	3.62	5.45	3.55	

Heat Mode

Air flow	outdoor air temp.	indoor air temp				
		16°CDB	18°CDB	20°CDB	22°CDB	24°CDB
Hi 10.7 (m³/min)	-15°CWB	3.69	3.61	3.53	3.45	3.38
	-10°CWB	4.18	4.10	4.05	3.95	3.86
	-5°CWB	4.52	4.46	4.37	4.32	4.25
	0°CWB	4.74	4.67	4.59	4.54	4.47
	5°CWB	6.04	5.97	5.94	5.82	5.74
	6°CWB	6.14	6.07	6.00	5.92	5.85
	10°CWB	6.52	6.46	6.42	6.34	6.27
15°CWB	7.10	7.04	6.99	6.91	6.85	
20°CWB	7.63	7.57	7.53	7.45	7.39	





2.5 Application data

2.5.1 Installation of indoor unit

RFB012A002 

This instruction manual illustrates the method of installing an indoor unit.
For electrical wiring work, please see instructions set out on the backside.
For outdoor unit installation and refrigerant piping, please refer to the installation manual that comes with your outdoor unit.
A wired remote control unit is supplied separately as an optional part.

SAFETY PRECAUTIONS

- Please read these "Safety Precautions" first then accurately execute the installation work.
- For installing qualified personnel, take precautions in respect to themselves by using suitable protective clothing, gloves, etc., and then perform the installation works.
- Though the precautionary points indicated herein are divided under two headings,  **WARNING** and  **CAUTION**, those points which are related to the strong possibility of an installation done in error resulting in death, serious injury or environmental pollution are listed in the  **WARNING** section. However, there is also a possibility of serious consequences in relationship to the points listed in the  **CAUTION** section as well. In either case, important safety related information is indicated, so by all means, properly observe all that is mentioned.
- Please pay attention not to fall down the tools, etc. when installing the unit at the high position.
- After completing the installation, along with confirming that no abnormalities were seen from the operation tests. Please explain operating methods as well as maintenance methods to the user (customer) of this equipment, based on the user's manual. Moreover, ask the customer to keep this sheet together with the user's manual.
- If unusual noise can be heard during operation, consult the dealer.

WARNING



- To disconnect the appliance from the mains supply this appliance must be connected to the mains by means of a circuit breaker or a switch (use a recognized 16A) with a contact separation of at least 3mm.
- The appliance shall be installed in accordance with national wiring regulations.
- When a plug is connected to the power cord, a plug conforming to the IEC60884-1 standard must be used.
- This system should be applied to places as households, residences and the like. Application to inferior environment such as engineering shop could cause equipment malfunction.
- Please entrust installation to either the company which sold you the equipment or to a professional contractor. Defects from improper installations can be the cause of water leakage, electric shocks and fires.
- Execute the installation accurately, based on following the installation manual. Again, improper installations can result in water leakage, electric shocks and fires.
- For installation, confirm that the installation site can sufficiently support heavy weight. When strength is insufficient, injury can result from a falling of the unit.
- For electrical work, please see that a licensed electrician executes the work while following the safety standards related to electrical equipment, and local regulations as well as the installation instructions, and that only exclusive use circuits are used.
- Insufficient power source circuit capacity and defective installment execution can be the cause of electric shocks and fires.
- Accurately connect wiring using the proper cable, and insure that the external force of the cable is not conducted to the terminal connection part, through properly securing it. Improper connection or securing can result in heat generation or fire.
- Take care that wiring does not rise upward, and accurately install the lid/service panel. It's improper installation can also result in heat generation or fire.
- Always use accessory parts and authorized parts for installation construction. Using parts not authorized by this company can result in water leakage, electric shock, fire and refrigerant leakage.
- Ventilate the work area when refrigerant leaks during the operation.
Coming in contact with fire, refrigerant could generate toxic gas.
- Confirm after the foundation construction work that refrigerant does not leak.
If coming in contact with fire of a fan heater, a stove or a movable cooking stove, etc., refrigerant leaking in the room could generate toxic gas.
- Turn off the power source during working on the inside of the unit such as servicing or installing work.
This may cause electric shock.
- Use only pipe, flare nut and tools that have been designed to operate with R410A.
Using existing parts (R22) may cause the unit failure, even as due to serious accident such as explosion of the cooling cycle or injury etc.
- For pump down work, stop the compressor before removing the refrigerant pipe.
If the refrigerant pipe is removed when the compressor is in operation with the service valves open (liquid side and gas side), air would be mixed in the refrigerant circuit and this may cause explosion and injuries due to abnormal high pressure in the cooling cycle.
- Connect the pipes for refrigerant circuit securely in installation work before compressor is operated
If the compressor is operated when the service valve is open without connecting the pipe, this may cause frostbite and injuries due to refrigerant leakage rapidly. Also, the unit is absorbed the air etc., this may cause explosion and injuries due to abnormal high pressure in the cooling cycle.
- Tighten the flare nut by torque wrench with specified method.
If the flare nut were tightened with excess torque, this may cause burst and refrigerant leakage after a long period, and then, this may cause generate the harmful substance due to touch the flammable materials.
- Make sure there is no dust or clogging on both plug and socket nor loose connection of the socket before plugging of the power plug. Then, the power plug must be inserted tightly.
Accumulation of dust, clogging on the socket or plug, or loose installation of the socket may cause electric shock and fire. Replace the socket if it is loose.
- Do not open the service valves (liquid side and gas side) until refrigerant piping construction, air-tightness test and evacuation are completed
This may cause frostbite and injuries due to refrigerant leakage rapidly. Also, if the refrigerant gas leakage occurs during installing work, stop the work such as brazing work and then ventilation of the room. This may cause generate the toxic gas due to touch the flammable materials.



- Do not put the drain pipe directly into the ditch where toxic gas such as sulfur is generated.
Toxic gas would flow into the room. Also, this may cause corrosion of indoor unit, and malfunction or refrigerant leakage.
- Be sure to bring back the packing material, form polystyrene, band and vinyl back etc., of the indoor and/or outdoor units after complete the installation work, and then implement appropriate measures such as breaking them.
- When setting up or moving the location of the air conditioner, do not mix air etc. or anything other than the designated refrigerant (R410A) within the refrigeration cycle. Rupture and injury caused by abnormal high pressure can result from such mixing.
- Do not processing, splice the power cord, or share a socket with other power plugs.
This may cause fire or electric shock due to defecting contact, defecting insulation and over-current etc.
- Do not bundling, winding or processing for the power cord. Or, do not deforming the power plug due to treat it This may cause fire or heating.
- Do not vent R410A into the atmosphere: R410A is a fluorinated greenhouse gas, covered by the Kyoto Protocol with a Global Warming Potential (GWP)=1975



- Execute proper grounding. Do not connect the ground wire to a gas pipe, water pipe, lightning rod or a telephone ground wire. Improper placement of ground wires can result in electric shock.

CAUTION



- Please avoid installing this unit in the locations where oil splashes and moisture are abundant (e.g., kitchens, mechanical workshops) or where the outside air is likely to flow in. These locations may cause corrosion and lower performance of the heat exchanger and cause damage to plastic parts.
- Please avoid installing this unit in the locations with corrosive gases (such as sulfurous acid gas), inflammable gases (such as thinner, gasoline) and areas where there are possibilities of gas accumulation or where a volatile inflammable material is handled. These locations can cause corrosion to the heat exchanger and damage to plastic parts. Also, the inflammable gas could cause fire.
- Please avoid installing this unit in the vicinity of equipment generating electromagnetic waves such as hospital equipment or equipment generating high-frequency waves. A failure to observe this instruction may result in controller performance errors due to noise generation.
- Please avoid installing and using this unit in a place where it is subject to sea breezes (coastal area). Installation in such a place may result in the corrosion of exterior panels and the heat exchanger.
- Do not place the remote control at locations that receives direct sunlight. This may cause malfunction and deformation.
- Spatters from welding, etc., if hit the unit, can damage (pinhole) its drain pan and other components and cause a water leak. Care must be taken in performing a welding operation near this unit and take necessary precautions to prevent spatters from entering this unit.
- For installation work, be careful not to get injured with the heat exchanger, piping flare portion or screws etc.
- For the drain pipe, follow the installation manual to insure that it allows proper drainage and thermally insulate it to prevent condensation. Inadequate plumbing can result in water leakage and water damage to interior items.
- The installation of an earth leakage breaker is necessary depending on the established location of the unit. Not installing an earth leakage breaker may result in electric shock.
- When perform the air conditioner operation (cooling or drying operation) in which ventilator is installed in the room. In this case, using the air conditioner in parallel with the ventilator, there is the possibility that drain water may backflow in accordance with the room lapse into the negative pressure status. Therefore, set up the opening port such as incorporate the air into the room that may appropriate to ventilation (For example; Open the door a little). In addition, just as above, so set up the opening port if the room lapse into negative pressure status due to register of the wind for the high rise apartment etc.
- Secure the regulated space for inspection and maintenance
When it is not possible to keep enough space, this may cause injury due to falling from the installation place.
- To prevent the falling, institute the everlasting ladder and handrail etc., to the aisle when installing the outdoor unit in the location with rooftop or altitude. Or, for surrounding of the outdoor unit, institute the fence and handrail etc., to the aisle to prevent the falling.
- Performing the heat insulation and condensation of the refrigerant piping
If the heat insulation and condensation of the refrigerant piping is not correctly, this may cause the water leakage, dew dropping and household wetting etc.
- Be careful not to injury due to damage of the unit installing work when leaving of the packaging materials.



- Do not install the unit where there is a concern about leakage of combustible gas.
The rare event of leaked gas collecting around the unit could result in an outbreak of fire.
- Do not touch the suction or aluminum fin on the outdoor unit
This may cause injury.
- Do not install the outdoor unit where is likely to be a nest for small animals
Small animals may come into the electronic components and may cause breakdown and fire. Also, instruct the user to keep the surroundings clean.
- Do not install the outdoor unit at the place where fan airflow falls on the garden tree etc.
This may cause damage to the garden tree etc., due to the fan airflow.
- Do not put anything on the outdoor unit and operating the unit.
This may cause damage the objects or injury due to falling to the object.

● Symbols which appear frequently in the text have the following meaning:



Strictly prohibited



Observe instructions with great care



Provide proper earthing

CAUTIONS FOR INSTALLATION

- The system should be applied to places as households, residences and the like.
- The equipment shall be installed in accordance with national wiring regulations.
- The connection to the fixed wiring of the mains supply must be made via a double pole isolating switch with a contact gap of at least 3mm in each pole.
- When the outdoor unit has a possibility of being overturned or being displaced and fall from its original installation position, the outdoor unit should be fixed in its position by use of anchor bolts or wires.

BEFORE INSTALLATION

Before installation check that the power supply matches the air conditioner.

Standard accessories (Installation kit)		Q'ty
Accessories for indoor unit		
①	Installation board (Attached to the rear of the indoor unit)	1
②	Wireless remote control	1
③	Remote control holder	1
④	Tapping screws (for installation board 4dia. by 25mm)	9
⑤	Wood screw (for remote control switch holder 3.5(mm), by 16mm)	2
⑥	Battery [R03(AAA, Micro) 1.5V]	2
⑦	Air-cleaning filters	2
⑧	Filter holders (Attached to the front panel of indoor unit)	2
⑨	Pipe cover (200mm)	1
⑩	Band	2

Option parts		Q'ty
a	Sealing plate	
b	Sleeve	1
c	Inclination plate	1
d	Putty	1
e	Drain hose (extension hose)	1
f	Piping cover (for insulation of connection piping)	1

Necessary tools for the installation work

1	Plus headed driver
2	Knife
3	Saw
4	Tape measure
5	Hammer
6	Spanner wrench
7	Torque wrench (14.0 - 61.0N*m (1.4 - 6.1kgf*m))
8	Hole core drill (65mm in diameter)
9	Wrench key (Hexagon) [4m/m]
10	Flaring tool set (Designed specifically for R410A)
11	Gas leak detector (Designed specifically for R410A)
12	Gauge for projection adjustment (Used when flare is made by using conventional flare tool)
13	Pipe bender

SELECTION OF INSTALLATION LOCATION

(Install at location that meets the following conditions, after getting approval from the customer)

Indoor unit

- Where there is no obstructions to the air flow and where the cooled and heated air can be evenly distributed.
- A solid place where the unit or the wall will not vibrate.
- A place where there will be enough space for servicing. (Where space mentioned below can be secured)
- Where wiring and the piping work will be easy to conduct.
- The place where receiving part is not exposed to the direct rays of the sun or the strong rays of the street lighting.
- A place where it can be easily drained.
- A place separated at least 1m away from the television or the radio. (To prevent interference to images and sounds.)
- Places where this unit is not affected by the high frequency equipment or electric equipment.
- Avoid installing this unit in place where there is much oil mist.
- Places where there is no electric equipment or household under the installing unit.
- Install the indoor unit on flat wall.

Wireless remote control

- A place where the air conditioner can be received the signal surely during operating the wireless remote control.
- Places where there is no affected by the TV and radio etc.
- Do not place where exposed to direct sunlight or near heat devices such as a stove.

INSTALLATION OF INDOOR UNIT

Open and detachment of the air inlet panel

- To open, pull the panel at both ends of upper part and release latches, and undo the strings. Then remove the panel.

CAUTION
When removing the air-inlet panel, be careful not to drop it on your feet.

How to remove the front panel

- Remove the air inlet panel.
- Remove the 5 set screws.
- Remove the 3 latches in the upper section. If the latches are difficult to remove, push the latch portion out using a screw driver, for example.
- Move the lower part of the panel forward and remove the 6 latches in the under section.

Drilling of holes and fixture of sleeve (Option parts)

When drilling the wall that contains a metal lath, wire lath or metal plate, be sure to use pipe hole sleeve sold separately.

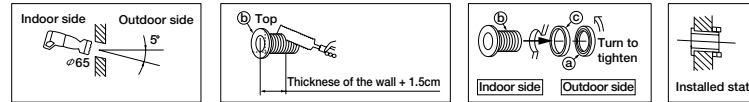

Drill a hole with whole core drill.

In case of rear piping draw out, cut off the lower and the right side portions of the sleeve collar.

Indoor unit piping direction

Piping is possible in the rear, left, left rear, left downward, right or downward direction.

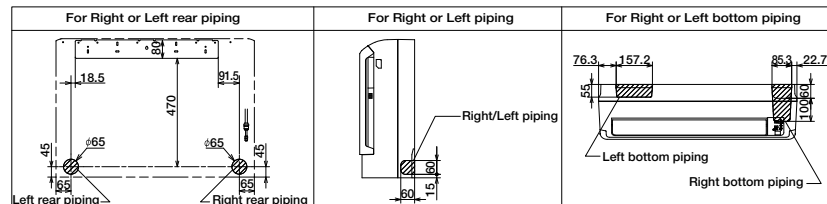
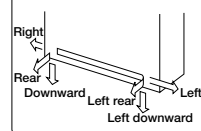

Drainage

- Arrange the drain hose in a downward angle
- Avoid the following drain piping.

CAUTION Go through all installation steps and check if the drainage is all right. Otherwise water leak may occur.

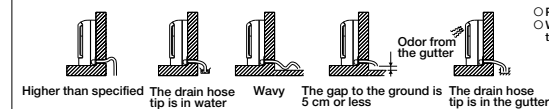

- Pour water to the drain pan located under the heat exchanger, and ensure that the water is discharged out
- When the extended drain hose is indoor, always use a shield pipe (to be arranged by the user) and ensure it thermally insulated

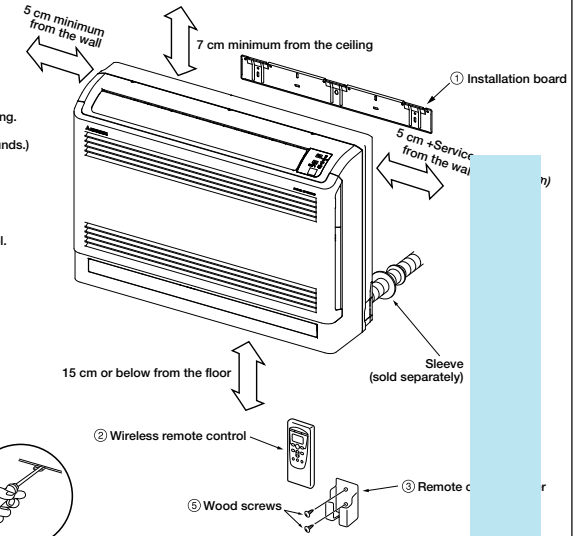
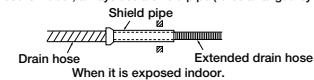

Installing the support of piping

In case of piping in the right rear direction

Taping of the exterior

- Tape only the portion that goes through the wall.
- Always tape the wire with the piping.

Fixing of indoor unit

CAUTION
During the installation, do not lean on the control box or the display, as they may be damaged.

Floor installation

Secure using lower 2 screws for floor installations. If possible, also attach two upper screws.

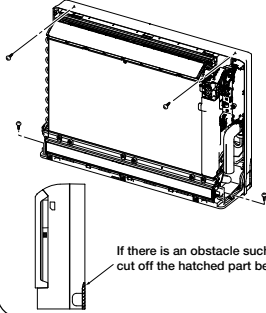

If there is an obstacle such as a cable cover, cut off the hatched part before installation.

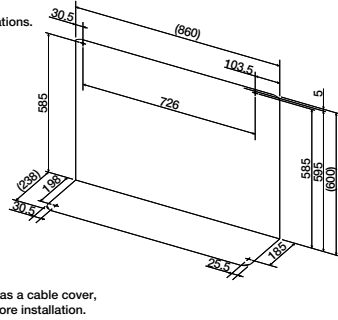

Wall installation

At first secure the installation board using 5 screws and the indoor unit using 2 screws.

Installation of Installation board

Look for the inside wall structures (Intersectants support or pillar and finally install the unit after level surface has been checked.)

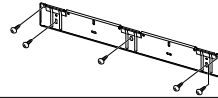

Fixing on concrete wall
Use of nut anchor

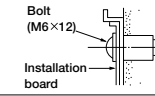

Adjustment of the installation board in the horizontal direction is to be conducted with five screws in a temporary tightened state.
Adjust so the board will be level by turning the board with the standard hole as the center.

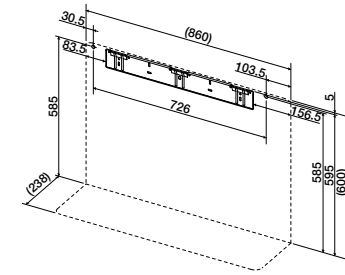
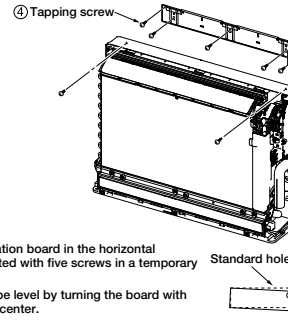

CONNECTION OF REFRIGERANT PIPINGS

Preparation Keep the openings of the pipes covered with tapes etc. to prevent dust, sand, etc. from entering them.

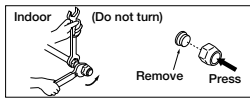

Remove the flared nuts. (on both liquid and gas sides)

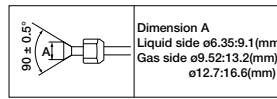

Install the removed flared nuts to the pipes to be connected, then flared the pipes.

Dimension A
Liquid side $\phi 6.35:9.1(\text{mm})$
Gas side $\phi 9.52:13.2(\text{mm})$
 $\phi 12.7:16.8(\text{mm})$

CAUTION
Do not apply refrigerating machine oil to the flared surface.

Flaring work

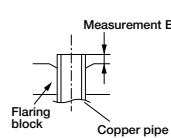

Copper pipe diameter	Measurement B (mm)		
	Clutch type flare tool for R410A	Conventional (R22) flare tool	
		Clutch type	Wing nut type
$\phi 6.35$	0.0 - 0.5	1.0 - 1.5	1.5 - 2.0
$\phi 9.52$	0.0 - 0.5	1.0 - 1.5	1.5 - 2.0
$\phi 12.7$	0.0 - 0.5	1.0 - 1.5	2.0 - 2.5

Use a flare tool designed for R410A or a conventional flare tool. Please note that measurement B (protrusion from the flaring block) will vary depending on the type of a flare tool in use. If a conventional flare tool is used, please use a copper pipe gauge or a similar instrument to check protrusion so that you can keep measurement B to a correct value.

CAUTION
Be careful not to stress the connecting refrigerant pipes.

Connection

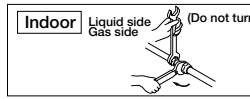

Connect the pipes on both liquid and gas sides.
Tighten the nuts to the following torque.
Liquid side ($\phi 6.35$) : 14.0 - 18.0 N·m (1.4 - 1.8 kgf·m)
Gas side ($\phi 9.52$) : 34.0 - 42.0 N·m (3.4 - 4.2 kgf·m)
($\phi 12.7$) : 49.0 - 61.0 N·m (4.9 - 6.1 kgf·m)

CAUTION
Do not apply excess torque to the flared nuts. Otherwise, the flared nuts may check depending.

Insulation of the connection portion

Pass the refrigerant pipe through the piping hole to indoor side.
Arrange the pipes according to the direction of piping.

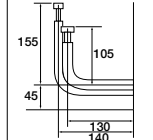

Cover the coupling with insulator and then cover it with tapes.
Use an attached pipe cover for heat insulation.

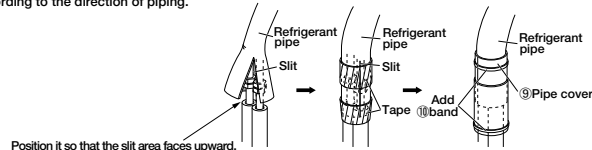

CAUTION
If heat insulation is insufficient, water leakage may occur. In addition, the room temperature sensor may give a false alert due to heat radiation from the pipes.

Cover the indoor unit's flare-connected joints, after they are checked for a gas leak, with an indoor unit heat insulating material and then wrap them with a tape with an attached pipe cover placed over the heat insulating material's slit area.

ELECTRICAL WIRING WORK

Preparation of indoor unit

Mounting of connecting wires

- Remove the fixing screw of clamp.
- Connect the connecting wire securely to the terminal block.
 - Connect the connection wire securely to the terminal block. If the wire is not affixed completely, contact will be poor, and it is dangerous as the terminal block may heat up and catch fire.
 - Take care not to confuse the terminal numbers for indoor and outdoor connections.
- Fix the connecting wire by wiring clamp.
- Pass the connecting wire through the wiring holder.

CAUTION
In case of faulty wiring connection, the indoor unit stops, and then the run lamp turns on and the timer lamp blinks.

Use cables for interconnection wiring to avoid loosening of the wires.
CENELEC code for cables Required field cables.

H05RNR4G1.5 (example) or 245IEC57
H Harmonized cable type
05 300/500 volts
R Natural-and/or synth, rubber wire insulation
N Polychloroprene rubber conductors insulation
R Stranded core
4or5 Number of conductors
G One conductor of the cable is the earth conductor (yellow/green)
1.5 Section of copper wire (mm²)

CAUTION
During installation, do not lean on the control box or the display, as they may be damaged.
Pass the connecting wire securely through the wiring holder. If it passes on the sensor, it may not detect suction temperature and/or humidity.

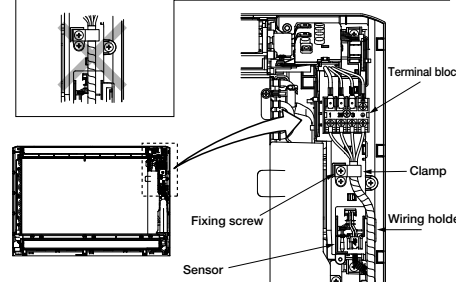

How to fit the front panel

- Fitting
- Do remove the air filter.
- Cover the body with the front panel.
- Fit the 6 latches in the lower section. then 3 latches in the upper section.
- Tighten the 5 set screws.
- Fit the air filter.
- Fit the air inlet panel.

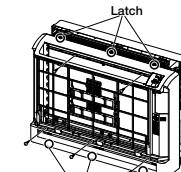

Close and attachment of the air inler panel

To close, attach the panel after pulling the strings, hold the panel at both ends of upper part to lower downward and push it slightly until the latch works.

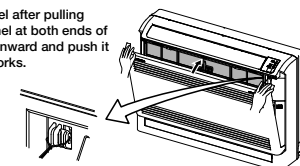

Concealed installation

- Install the indoor unit according to the following instructions.
- Secure the upper, right, and left spaces according to the right figure.
 - Do not let the horizontal bar obstruct wind from blowing out upward/downward or reception from the remote controller.
 - The lattice size should be 70 % or greater of the open rate.
 - Cut the jumper cable (JP173) on the indoor circuit board to control the blow-out angle.

CAUTION
Incorrect installation may cause problems such as non-cooling, non-warming, and condensation water leaking into the room.

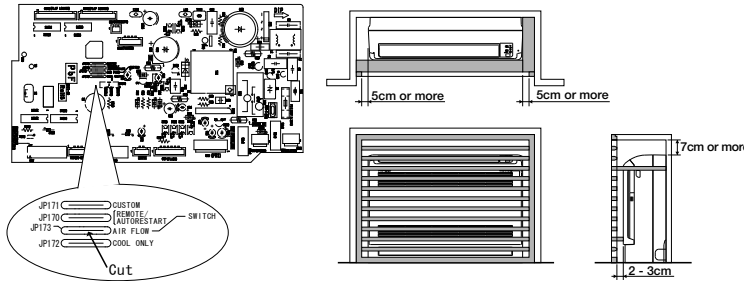

Installing the air-cleaning filters

- Open the air inlet panel and remove the air filters.
- Install the filter holders, with the air-cleaning filters installed in the holders. In the air conditioner.
 - Each air-cleaning filter can be installed in the upper or lower filter holder.
- Install the air filters and close the inlet panel.

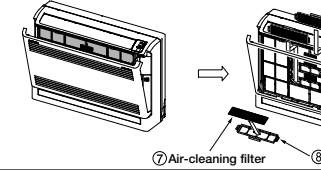

CAUTION
When installing an air-cleaning filter in the indoor unit, be careful not to touch your hand with the heat exchanger.

INSTALLATION OF REMOTE CONTROL

Mounting method of battery

- Uncover the wireless remote control, and mount the batteries [R03(AAA, Micro), ×2 pieces] in the body regularly. (Fit the poles with the indication marks, ⊕ & ⊖ without fall)

CAUTION
Do not use new and old batteries together.

Fixing to pillar or wall

- Conventionally, operate the remote control switch by holding in your hand.
- Avoid installing it on a clay wall etc.

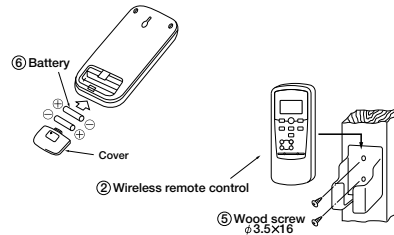

HOW TO RELOCATE OR DISPOSE OF THE UNIT

- In order to protect the environment, be sure to pump down (recovery of refrigerant).
- Pump down is the method of recovering refrigerant from the indoor unit to the outdoor unit when the pipes are removed from the unit.

- Forced cooling operation**
Turn on a power supply again after a while after turning off the power supply. Then press continually the ON/OFF button 5 seconds.

<How to pump down>

- Connect charge hose to service port of outdoor unit.
- Liquid side : Close the liquid valve with hexagon wrench key.
Gas side : Fully open the gas valve
Carry out cooling operation . (If indoor temperature is low, operate forced cooling operation.)
- After low pressure gauge become 0.01MPa, stop cooling operation and close the gas valve.

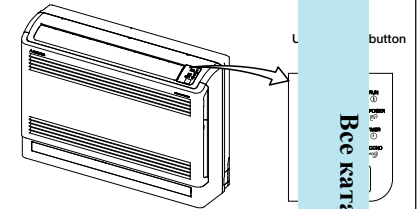

INSTALLATION TEST CHECK POINTS

Check the following points again after completion of the installation, and before turning on the power. Conduct a test run again and ensure that the unit operates properly. At the same time, explain to the customer how to use the unit and how to take care of the unit following the user's manual.

After installation

- The power supply voltage is correct as the rating.
- No gas leaks from the joints of the operational valve.
- Power cables and crossover wires are securely fixed to the terminal board.
- Operational valve is fully open.
- The pipe joints for indoor and outdoor pipes have been insulated.

Test run

- Air conditioning operation is normal.
 - No abnormal noise.
 - Water drains smoothly.
 - Protective functions are not working.
 - The remote control is normal.
- Operation of the unit has been explained to the customer. (Three-minutes restart preventive timer)
When the air conditioner is restarted or when changing the operation, the unit will not start operating for approximately 3 minutes.
This is to protect the unit and it is not a malfunction.

CONCERNING TERMINAL CONNECTION FOR AN INTERFACE

- Remove the front panel and lid of control.
- There is a terminal (respectively marked with CNS) for the indoor control box. In connecting an interface, connect to the respective terminal securely with the harness supplied with an optional "Interface connection kit SC-BIKN-E". For more details, please refer to the user's manual of your "Interface connection kit SC-BIKN-E".

2.5.2 Installation of outdoor unit

Models SRC25ZIX-S, 35ZIX-S

Refer to page 18.

Model SRC50ZIX-S

Все каталоги и инструкции здесь: <http://splitoff.ru/tehn-doc.html>

2.6 Outline of operation control by microcomputer

2.6.1 Operation control function by remote controller

Operation section

Все каталоги и инструкции здесь: <http://splitoff.ru/tehn-doc.html>

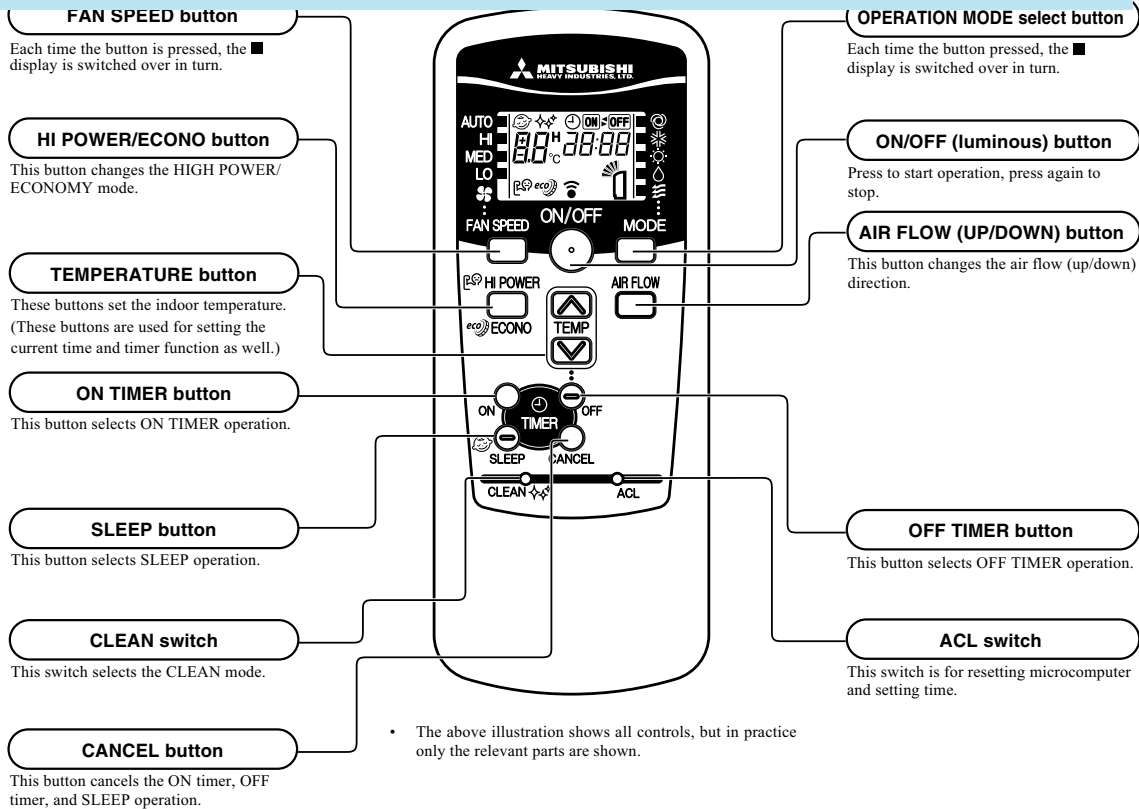

Unit display section

Model All models

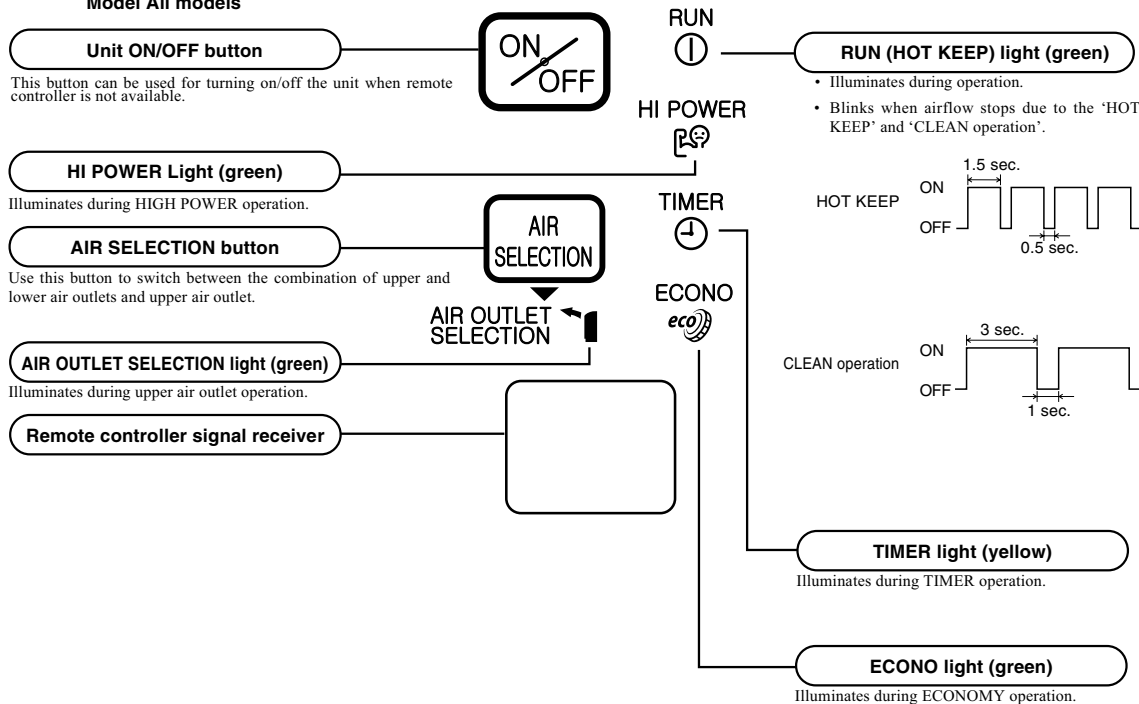

2.6.2 Unit ON/OFF button

When the remote controller batteries become weak, or if the remote controller is lost or malfunctioning, this button may be used to turn the unit on and off.

Все каталоги и инструкции здесь: <http://splitoff.ru/tehn-doc.html>

(2) Details of operation

The unit will go into the automatic mode in which it automatically determines, from indoor temperature (as detected by sensor), whether to go into the cooling, thermal dry or heating modes.

Function operation mode	Indoor temperature setting	Fan speed	Flap/Louver	Timer Switch
Cooling	About 24°C	Auto	Auto	Continuous
Thermal dry	About 25°C			
Heating	About 26°C			

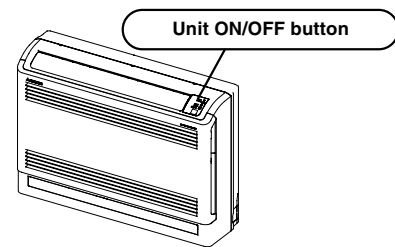

2.6.3 Auto restart function

(1) Auto restart function records the operational status of the air-conditioner immediately prior to be switched off by a power cut, and then automatically resumes operations after the power has been restored.

(2) The following settings will be cancelled:

- (a) Timer settings
- (b) HIGH POWER operations

Notes (1) Auto restart function is set at on when the air-conditioner is shipped from the factory. Consult with your dealer if this function needs to be switched off.
 (2) When power failure occurs, the timer setting is cancelled. Once power is resumed, reset the timer.
 (3) If the jumper wire (J170) "AUTO RESTART" is cut, auto restart is disabled. (See the diagram at right)

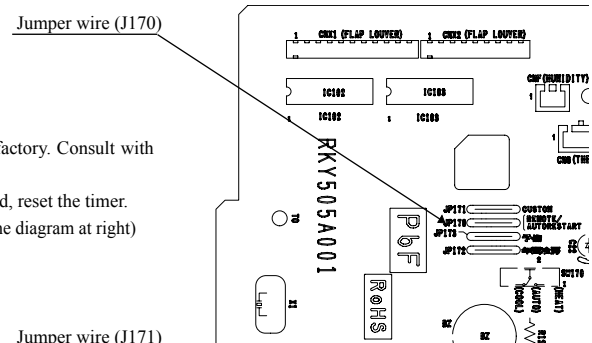

2.6.4 Custom cord switching procedure

If two wireless remote controller are installed in one room, in order to prevent wrong operation due to mixed signals, please modify the printed circuit board in the indoor unit's control box and the remote controller using the following procedure. Be sure to modify both boards. If only one board is modified, receiving (and operation) cannot be done.

(1) Modifying the indoor printed circuit board

Take out the printed circuit board from the control box and cut off jumper wire (J171) using wire cutters.

After cutting of the jumper wire, take measures to prevent contact with the other the lead wires, etc.

(2) Modifying the wireless remote controller

- (a) Remove the battery.
- (b) Cut the jumper wire shown in the figure at right.

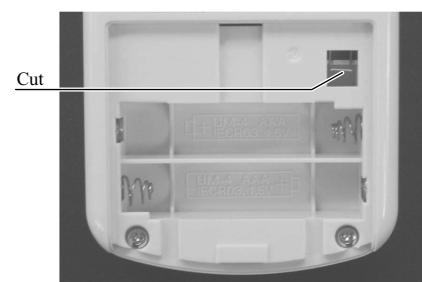
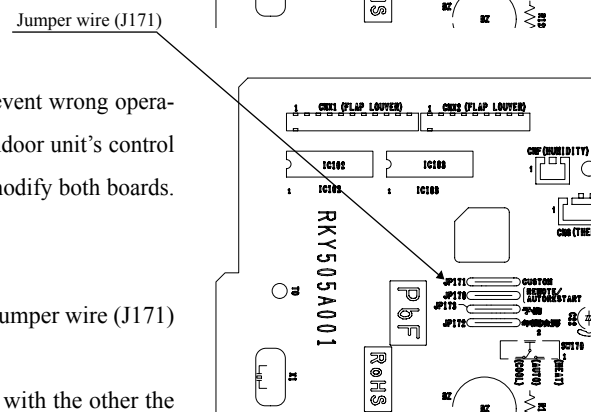

2.6.5 Flap control





Control the flap by AIRFLOW  (UP/DOWN) button on the wireless remote controller.

(1) Flap

Все каталоги и инструкции здесь: <http://splitoff.ru/tehn-doc.html>



• Angle of Flap from Horizontal

Remote controller display					
COOL , DRY , FAN	Approx. 60°	Approx. 50°	Approx. 38°	Approx. 21.5°	Approx. 12°
HEAT	Approx. 44°	Approx. 32°	Approx. 21.5°	Approx. 12°	Approx. 5°

(2) Swing

(a) Swing flap

Flap moves in upward and downward directions continuously.

◆ In HEAT operation

◆ In COOL, DRY, FAN operation

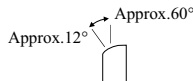
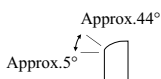

(3) Memory flap (Flap stopped)

When you press the AIRFLOW button once while the flap is operating, it stops swinging at the position. Since this angle is memorized in the microcomputer, the flap will automatically be set at this angle when the next operation is started.

(4) When not operating

The flap returns to the position of air flow directly below, when operation has stopped.

2.6.6 Air outlet selection

(1) AIR SELECTION button can switch between the combination of upper and lower air outlets and upper air outlet. Not operable while the air conditioner is OFF.

(a) Each time the AIR SELECTION button is pressed. The combination of the upper and lower air outlets and the upper air outlet can be switched.

(b) When the upper air outlet is selected, AIR OUTLET SELECTION light on the unit display area will light green.

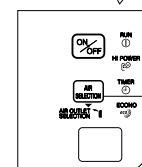
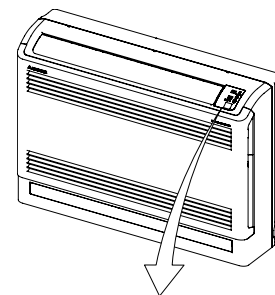

AIR SELECTION button

(2) Auto air outlet selection

(a) COOL, DRY operation

1) In case both lower and upper outlets operation is selected in Cooling or Dry operation, both outlets will be kept for sixty minutes after the start or until indoor

Все каталоги и инструкции здесь: <http://splitoff.ru/tehn-doc.html>

2) In case both outlets operation with Auto fan speed mode is selected, the upper outlet will be kept for ten minutes after the start or until indoor temperature is close to reaching the setting point. And then the air outlet will change to both outlets in order to spread comfort air to every corner.

(b) HEAT operation

1) In case both lower and upper outlets operation with Auto fan speed mode is selected, the lower outlet will be kept for twenty minutes after the start or until room temperature is close to reaching the setting point. And then the air outlet will change to both outlets. That state will be maintained until the switch is turned off.

2) Automatic adjustment of lower air outlet direction prevents stirring up of warm air and keeps optimum comfort at floor level.

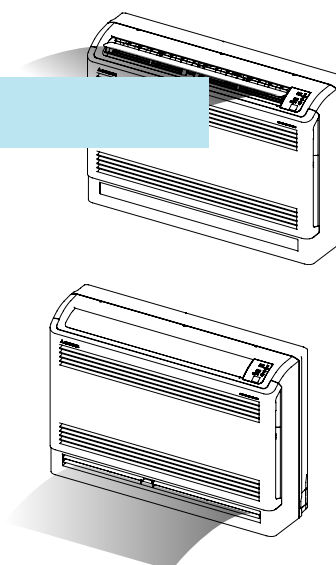

2.6.7 Timer operation

(1) Comfortable timer setting (ON timer)

If the timer is set at ON when the operation select switch is set at the cooling or heating, or the cooling or heating in auto mode operation is selected, the comfortable timer starts and determines the starting time of next operation based on the initial value of 15 minutes and the relationship between the indoor temperature at the setting time (temperature of room temperature sensor) and the setting temperature.

(2) Sleep timer operation

Pressing the SLEEP button causes the temperature to be controlled with respect to the set temperature.

(3) OFF timer operation

The Off timer can be set at a specific time (in 10-minute units) within a 24-hour period.

2.6.8 Outline of heating operation

(1) Operation of major functional components in heating mode

	Heating		
	Thermostat ON	Thermostat OFF	Failure
Compressor	ON	OFF	OFF
Indoor fan motor	ON	ON(HOT KEEP)	OFF
Outdoor fan motor	ON	OFF (few minutes ON)	OFF
4-way valve	ON	ON	OFF (3 minutes ON)

(2) Details of control at each operation mode (pattern)

(a) Fuzzy operation

Deviation between the indoor temperature setting correction temperature and the return air temperature is calculated in accordance with the fuzzy rule, and used for control of the air capacity and the compressor speed.

Model	SRF25ZIX-S	SRF35ZIX-S	SRF50ZIX-S
Fan speed			
Auto	30~102rps	30~115rps	12~110rps
HI	30~102rps	30~115rps	12~110rps
MED	30~76rps	30~106rps	12~80rps
LO	30~58rps	30~80rps	12~60rps

When the defrosting, protection device, etc. is actuated, operation is performed in the corresponding mode.

(b) Hot keep operation

If the hot keep operation is selected during the heating operation, the indoor blower is controlled based on the temperature of the indoor heat exchanger (Th2) to prevent blowing of cool wind.

(3) Defrosting operation

(a) Starting conditions (Defrosting operation can be started only when all of the following conditions are met.)

1) After start of heating operation

When it elapsed 45 (model 50 : 35) minutes. (Accumulated compressor operation time)

Все каталоги и инструкции здесь: <http://splitoff.ru/tehn-doc.html>

3) Outdoor heat exchanger sensor (TH1) temperature

When the temperature has been below -5°C for 3 minutes continuously.

4) The difference between the outdoor air sensor temperature and the outdoor heat exchanger sensor temperature

- The outdoor air temperature $\geq 0^{\circ}\text{C}$ (model 50 : $\geq -2^{\circ}\text{C}$) : 7°C or higher

- $-15^{\circ}\text{C} \leq$ The outdoor air temperature $< 0^{\circ}\text{C}$ (model 50 : $< -2^{\circ}\text{C}$) : $4/15 \times$ The outdoor air temperature + 7°C or higher

- The outdoor air temperature $< -15^{\circ}\text{C}$: -5°C or higher

5) During continuous compressor operation

In addition, when the speed command from the indoor controller of the indoor unit during heating operation has counted 0 rps 10 times or more and all conditions of 1), 2), 3) and 5) above and the outdoor air temperature is 3°C or less are satisfied (note that when the temperature for outdoor heat exchanger sensor (TH1) is -5°C or less: 62 rps or more, -4°C or less: less than 62 rps), defrost operation is started.

(b) Ending conditions (Operation returns to the heating cycle when either one of the following is met.)

1) Outdoor heat exchanger sensor (TH1) temperature: 13°C (model 50 : 10°C) or higher

2) Continued operation time of defrosting \rightarrow For more than 15 min.

2.6.9 Outline of cooling operation

(1) Operation of major functional components in Cooling mode

	Cooling		
	Thermostat ON	Thermostat OFF	Failure
Compressor	ON	OFF	OFF
Indoor fan motor	ON	ON	OFF
Outdoor fan motor	ON	OFF (few minutes ON)	OFF (few minutes ON)
4-way valve	OFF	OFF	OFF

(2) Detail of control in each mode (Pattern)

(a) Fuzzy operation

During the fuzzy operation, the air flow and the compressor speed are controlled by calculating the difference between the indoor temperature setting correction temperature and the return air temperature.

Fan speed \ Model	SRF25ZIX-S	SRF35ZIX-S	SRF50ZIX-S
Auto	20~72rps	20~104rps	12~86rps
HI	20~72rps	20~104rps	12~86rps
MED	20~48rps	20~70rps	12~58rps
LO	20~34rps	20~46rps	12~38rps

2.6.10 Outline of automatic operation

(1) Determination of operation mode

The unit checks the indoor temperature and the outdoor air temperature, determines the operation mode, and then begins in the

Все каталоги и инструкции здесь: <http://splitoff.ru/tehn-doc.html>

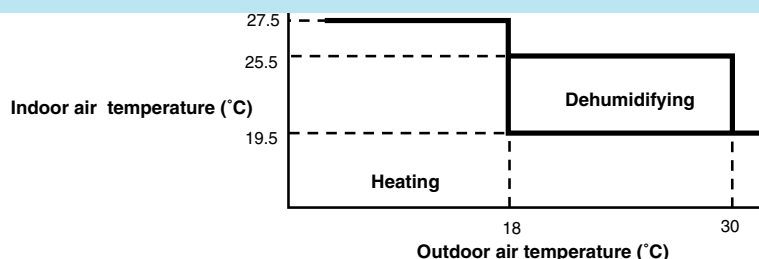

- (2) The unit checks the temperature every hour after the start of operation and, if the result of check is not same as the previous operation mode, changes the operation mode.
- (3) When the unit is started again within one hour after the stop of automatic operation or when the automatic operation is selected during heating, cooling or dehumidifying operation, the unit is operated in the previous operation mode.
- (4) Setting temperature can be adjusted within the following range. There is the relationship as shown below between the signals of the wireless remote controller and the setting temperature.

		Signals of wireless remote controller (Display)												
		-6	-5	-4	-3	-2	-1	±0	+1	+2	+3	+4	+5	+6
Setting temperature	Cooling	18	19	20	21	22	23	24	25	26	27	28	29	30
	Dehumidifying	19	20	21	22	23	24	25	26	27	28	29	30	31
	Heating	20	21	22	23	24	25	26	27	28	29	30	31	32

Unit : °C

2.6.11 Protective control function

(1) Frost prevention control (During cooling or dehumidifying)

(a) Operating conditions

- 1) Indoor heat exchanger temperature (Th2) is lower than 5°C.
- 2) 5 minutes after reaching the compressor command speed except 0 rps.

(b) Detail of anti-frost operation

Indoor heat exchanger temperature	5°C or lower	2.5°C or lower
Item		
Lower limit of compressor command speed	22 rps (model 50 : 25 rps)	0 rps
Indoor fan	Depends on operation mode	Protects the fan tap just before frost prevention control
Outdoor fan	Depends on command speed	Depends on stop mode
4-way valve	OFF	

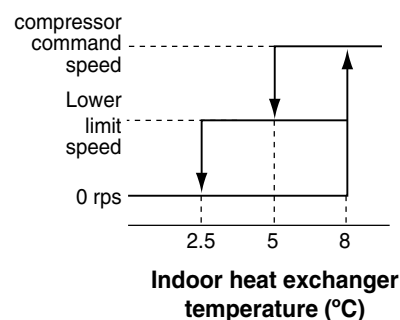

- Notes
- (1) When the indoor heat exchanger temperature is in the range of 2.5~5 °C, the speed is reduced by 4 rps at each 20 seconds.
 - (2) When the temperature is lower than 2.5 °C, the compressor is stopped.
 - (3) When the indoor heat exchanger temperature is in the range of 5~8 °C, the compressor command speed is been maintained.

(c) Reset conditions: When either of the following condition is satisfied.

- 1) The indoor heat exchanger temperature (Th2) is 8°C or higher.
- 2) The compressor command speed is 0 rps.

(2) Cooling overload protective control

(a) Operating conditions: When the outdoor air temperature (TH2) has become continuously for 30 seconds at 41°C or more, or 47°C or more (Models 50, 60: 41°C or more) with the compressor running, the lower limit speed of compressor is brought up.

Все каталоги и инструкции здесь: <http://splitoff.ru/tehn-doc.html>

SRF50ZIX-S

Outdoor air temperature	41°C or more	47°C or more	41°C or more
Lower limit speed	30 rps	40 rps	30 rps

(b) Detail of operation

- 1) The outdoor fan is stepped up by 3 speed step. (Upper limit 7th (model 50 : 8th) speed.)
- 2) The lower limit of compressor command speed is set to 30 or 40 (SRF50 : 30) rps and even if the calculated result becomes lower than that after fuzzy calculation, the speed is kept to 30 or 40 (SRF50 : 30) rps. However, when the thermo becomes OFF, the speed is reduced to 0 rps.

(c) Reset conditions: When either of the following condition is satisfied.

- 1) The outdoor air temperature is lower than 40°C or 46°C.
- 2) The compressor command speed is 0 rps.

(3) Cooling high pressure control

(a) Purpose: Prevents anomalous high pressure operation during cooling.

(b) Detector: Outdoor heat exchanger sensor (TH1)

(c) Detail of operation:

(Example) Fuzzy

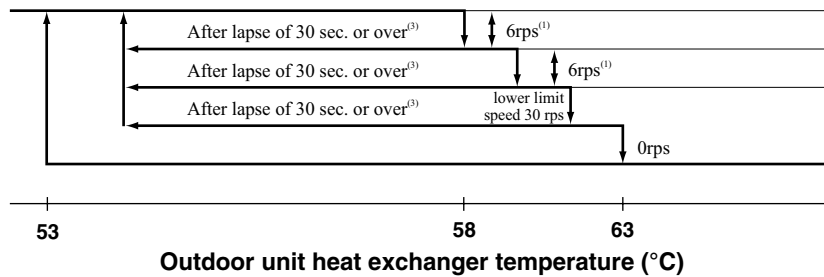

- Notes
- (1) When the outdoor heat exchanger temperature is in the range of 58~63 °C, the speed is reduced by 6 rps at each 30 seconds.
 - (2) When the temperature is 63 °C or higher, the compressor is stopped.
 - (3) When the outdoor heat exchanger temperature is in the range of 53~58 °C, if the compressor command speed is been maintained and the operation has continued for more than 30 seconds at the same speed, it returns to the normal cooling operation.

(4) Cooling low outdoor temperature protective control

(a) Operating conditions: When the outdoor air temperature (TH2) is 22°C or lower continues for 20 seconds while the compressor command speed is other than 0 rps.

(b) Detail of operation:

- 1) The lower limit of the compressor command speed is set to 44 (30) rps and even if the speed becomes lower than 44 (30) rps, the speed is kept to 44 (30) rps. However, when the thermo becomes OFF, the speed is reduced to 0 rps.
- 2) The upper limit of the compressor command speed is set to 50 (60) rps and even if the calculated result becomes higher than that after fuzzy calculation, the speed is kept to 50 (60) rps.

Note (1) Values in () are for outdoor air temperature is 22°C or 25°C

ON (Upper limit 50 rps
Lower limit 44 rps)

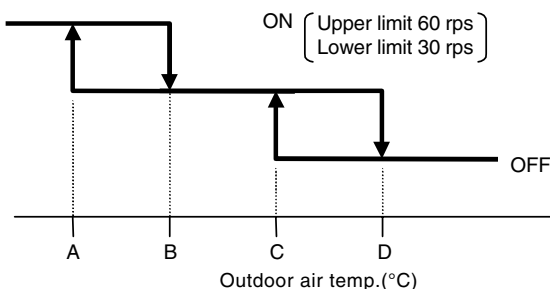

● Values of A, B, C, D

	Outdoor air temp. (°C)			
	A	B	C	D
First time	0	3	22	25
Since the seconds times	7	10	25	28

(c) **Reset conditions:** When either of the following condition is satisfied

- 1) The outdoor air temperature (TH2) is D °C or higher.
- 2) The compressor command speed is 0 rps.

Все каталоги и инструкции здесь: <http://splitoff.ru/tehn-doc.html>

(b) **Detector:** Indoor heat exchanger sensor (Th2)

(c) **Detail of operation:**

(Example) Fuzzy

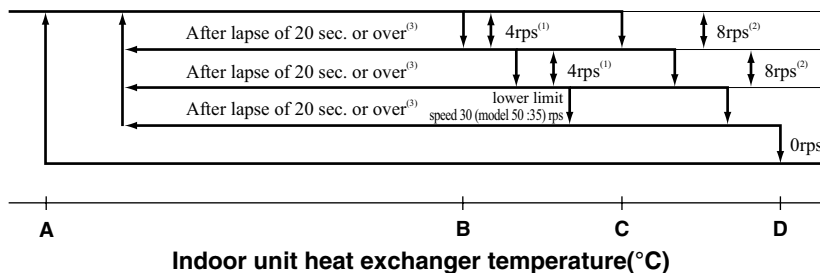

- Notes
- (1) When the indoor heat exchanger temperature is in the range of B~C °C, the speed is reduced by 4 rps at each 20 seconds.
 - (2) When the indoor heat exchanger temperature is in the range of C~D °C, the speed is reduced by 8 rps at each 20 seconds. When the temperature is D °C or higher continues for 1 minute, the compressor is stopped.
 - (3) When the indoor heat exchanger temperature is in the range of A~B °C, if the compressor command speed is been maintained and the operation has continued for more than 20 seconds at the same speed, it returns to the normal heating operation.
 - (4) Indoor blower retains the fan tap when it enters in the high pressure control. Outdoor blower is operated in accordance with the speed.

● **Temperature list**

Models : 25 , 35

Unit : °C

	A	B	C	D
RPSmin < 50	48	53	55	58
50 ≤ RPSmin < 104	48.5	56	58	61
104 ≤ RPSmin	42.1	44	47.3	61

Model : 50

Unit : °C

	A	B	C	D
RPSmin < 88	48.5	56	58	61
88 ≤ RPSmin < 108	44	51.5	53.5	56.5
108 ≤ RPSmin	39	46.5	48.5	51.5

Note (1) RPSmin: The lower one between the outdoor speed and the compressor command speed

(6) **Heating overload protective control**

(a) **Operating conditions:** When the outdoor air temperature (TH2) is 22°C (model 50 : 17°C) or higher continues for 30 seconds while the compressor command speed other than 0 rps.

(b) **Detail of operation:**

- 1) Taking the upper limit of compressor command speed range at 60 rps (model 50 : 50 rps), if the output speed obtained with the fuzzy calculation exceeds the upper limit, the upper limit value is maintained.
- 2) The lower limit of compressor command speed is set to 40 rps (model 50 : 35 rps) and even if the calculated result becomes lower than that after fuzzy calculation, the speed is kept to 40 rps (model 50 : 35 rps). However, when the thermo becomes OFF, the speed is reduced to 0 rps.
- 3) Inching prevention control is activated and inching prevention control is carried out with the minimum speed set at 40 rps (model 50 : 35 rps).
- 4) The outdoor fan is set on 2nd speed.
- 5) The indoor fan is stepped up by 1 speed step. (Upper limit 8th speed)

(c) **Reset conditions:** The outdoor air temperature (TH2) is lower than 21°C (model 50 : 16°C).

(7) Heating low outdoor temperature protective control

• **Models : 20 , 35**

(a) Operating conditions: When the outdoor air temperature (TH2) is lower than -10°C or higher continues for 30 seconds while the compressor command speed is other than 0 rps.

Все каталоги и инструкции здесь: <http://splitoff.ru/tehn-doc.html>

below.

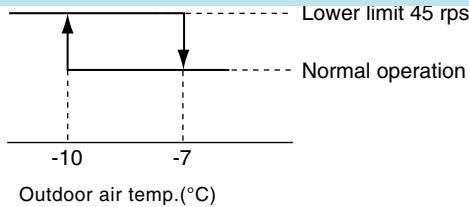

(c) Reset conditions: When either of the following condition is satisfied.

- 1) The outdoor air temperature (TH2) becomes -7°C .
- 2) The compressor command speed is 0 rps.

• **Model 50**

(a) Operating conditions: When the outdoor air temperature (TH2) is lower than 4°C or 13°C or higher continues for 30 seconds while the compressor command speed is other than 0 rps.

(b) Detail of operation: The lower limit compressor command speed is change as shown in the figure below.

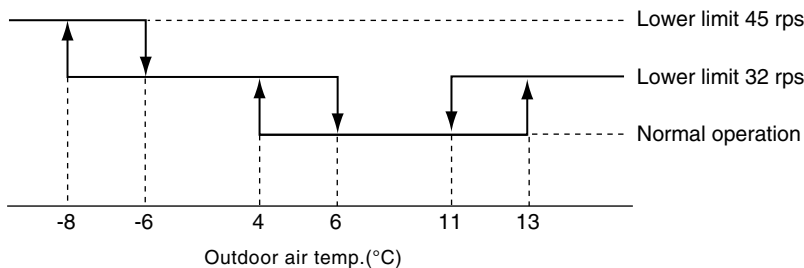

(c) Reset conditions: When either of the following condition is satisfied.

- 1) The outdoor air temperature (TH2) becomes $6^{\circ}\text{C} \sim 11^{\circ}\text{C}$.
- 2) The compressor command speed is 0 rps.

(8) Compressor overheat protection

(a) Purpose: It is designed to prevent deterioration of oil, burnout of motor coil and other trouble resulting from the compressor overheat.

(b) Detail of operation

1) Speeds are controlled with temperature detected by the sensor mounted on the discharge pipe.

(Example) Fuzzy

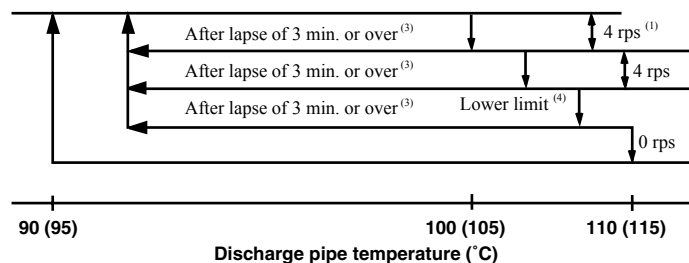

• Figures in () are for model 50.

- Notes
- (1) When the discharge pipe temperature is in the range of $100\sim 110^{\circ}\text{C}$ (model 50 : $105\sim 115^{\circ}\text{C}$), the speed is reduced by 4 rps.
 - (2) When the discharge pipe temperature is raised and continues operation for 20 seconds without changing, then the speed is reduced again by 4 rps.
 - (3) If the discharge pipe temperature is in the range of $90\sim 100^{\circ}\text{C}$ (model 50 : $95\sim 105^{\circ}\text{C}$) even when the compressor command speed is maintained for 3 minutes when the temperature is in the range of $90\sim 100^{\circ}\text{C}$ (model 50 : $95\sim 105^{\circ}\text{C}$), the speed is raised by 1 rps and kept at that speed for 3 minutes. This process is repeated until the command speed is reached.

(4) Lower limit speed

Model	Item	Cooling	Heating
		25,35	20 rps
Lower limit speed	50	25 rps	32 rps

- 2) If the temperature of 110°C (model 50 : 115°C) is detected by the sensor on the discharge pipe, then the compressor will stop immediately.
When the discharge pipe temperature drops and the time delay of 3 minutes is over, the unit starts again within 1 hour but there is no start at the third time.

Все каталоги и инструкции здесь: <http://splitoff.ru/tehn-doc.html>

(a) **Purpose:** Current is controlled not to exceed the upper limit of the setting operation current.

- (b) **Detail of operation:** Input current to the converter is monitored with the current sensor fixed on the printed circuit board of the outdoor unit and, if the operation current value reaches the limiting current value, the compressor command speed is reduced.
If the mechanism is actuated when the compressor command speed is less than 30 rps, the compressor is stopped immediately. Operation starts again after a delay time of 3 minutes.

(10) Current cut

- (a) **Purpose:** Inverter is protected from overcurrent.
(b) **Detail of operation:** Output current from the inverter is monitored with a shunt resistor and, if the current exceeds the setting value, the compressor is stopped immediately. Operation starts again after a delay time of 3 minutes.

(11) Outdoor unit failure

This is a function for determining when there is trouble with the outdoor unit during air conditioning.

The compressor is stopped if any one of the following in item (a), (b) is satisfied. Once the unit is stopped by this function, it is not restarted.

- (a) When the input current is measured at 1 A or less for 3 continuous minutes or more.
(b) If the outdoor unit sends a 0 rps signal to the indoor unit 3 times or more within 20 minutes of the power being turned on.

(12) Indoor fan motor protection

When the air conditioner is operating and the indoor fan motor is turned ON, if the indoor fan motor has operated at 150 rpm or under for more than 30 seconds, the unit enters first in the stop mode and then stops the entire system.

(13) Serial signal transmission error protection

- (a) **Purpose:** Prevents malfunction resulting from error on the indoor ↔ outdoor signals.
(b) **Detail of operation:** If the compressor is operating and a serial signal cannot be received from the indoor control with outdoor control having serial signals continues for 7 minute and 35 seconds, the compressor is stopped.
After the compressor has been stopped, it will be restarted after the compressor start delay if a serial signal can be received again from the indoor control.

(14) Rotor lock

If the motor for the compressor does not turn after it has been started, it is determined that a compressor lock has occurred and the compressor is stopped.

(15) Outdoor fan motor protection

If the outdoor fan motor has operated at 75 rpm or under for more than 30 seconds, the compressor and fan motor are stopped.

(16) Outdoor fan control at low outdoor temperature

◆ **Cooling**

- (a) Operating conditions:** When the outdoor air temperature (TH2) is 22°C or lower continues for 30 seconds while the compressor command speed is other than 0 rps.

Все каталоги и инструкции здесь: <http://splitoff.ru/tehn-doc.html>

r heat

● Value of A

	Outdoor fan
Outdoor temperature > 10°C	2nd speed
Outdoor temperature ≤ 10°C	1st speed

- 1) Outdoor heat exchanger temperature $\leq 21^{\circ}\text{C}$
After the outdoor fan speed drops (down) to 1 speed for 60 seconds; if the outdoor heat exchanger temperature is lower than 21°C, gradually reduce the outdoor fan speed by 1 speed. (Lower limit 1st speed)
 - 2) $21^{\circ}\text{C} < \text{Outdoor heat exchanger temperature} \leq 38^{\circ}\text{C}$
After the outdoor fan speed maintains at A speed for 20 seconds; if the outdoor heat exchanger temperature is 21°C~38°C, maintain outdoor fan speed.
 - 3) Outdoor heat exchanger temperature > 38°C
After the outdoor fan speed rises (up) to 1 speed for 60 seconds; if the outdoor heat exchanger temperature is higher than 38°C, gradually increase outdoor fan speed by 1 speed. (Upper limit 3rd speed)
- (c) Reset conditions:** When either of the following conditions is satisfied
- 1) The outdoor air temperature (TH2) is 25°C or higher.
 - 2) The compressor command speed is 0 rps.
- ◆ **Heating**
- (a) Operating conditions:** When the outdoor air temperature (TH2) is 4°C or lower continues for 30 seconds while the compressor command speed is other than 0 rps.
- (b) Detail of operation:** The outdoor fan is stepped up by 2 speed step at each 20 seconds. (Upper limit 8th speed)
- (c) Reset conditions:** When either of the following conditions is satisfied
- 1) The outdoor air temperature (TH2) is 6°C or higher.
 - 2) The compressor command speed is 0 rps.

3 MAINTENANCE DATA

3.1 Troubleshooting procedures for electrical equipment

(1) Cautions

Все каталоги и инструкции здесь: <http://splitoff.ru/tehn-doc.html>

When working on indoor units, let the unit sit for about 1 minute after turning on the power before you begin work. When working on an outdoor unit, there may be an electrical charge applied to the main circuit (electrolytic condenser), so begin work only after discharging this electrical charge (to DC 10 V or lower).

- (b) When taking out printed circuit boards, be sure to do so without exerting force on the circuit boards or package components.
- (c) When disconnecting and connecting connectors, take hold of the connector housing and do not pull on the lead wires.

(2) Items to check before troubleshooting

- (a) Have you thoroughly investigated the details of the trouble which the customer is complaining about?
- (b) Is the air conditioner running? Is it displaying any self-diagnosis information?
- (c) Is a power supply with the correct voltage connected?
- (d) Are the control lines connecting the indoor and outdoor units wired correctly and connected securely?
- (e) Is the outdoor unit's service valve open?

(3) Troubleshooting procedure (If the air conditioner does not run at all)

If the air conditioner does not run at all, diagnose the trouble using the following troubleshooting procedure. If the air conditioner is running but breaks down, proceed to troubleshooting step (4).

Important When all the following conditions are met, we say that the air conditioner will not run at all.

- (a) The RUN light does not light up.
- (b) The flaps do not open.
- (c) The indoor unit fan motors do not run.
- (d) The self-diagnosis display does not function.

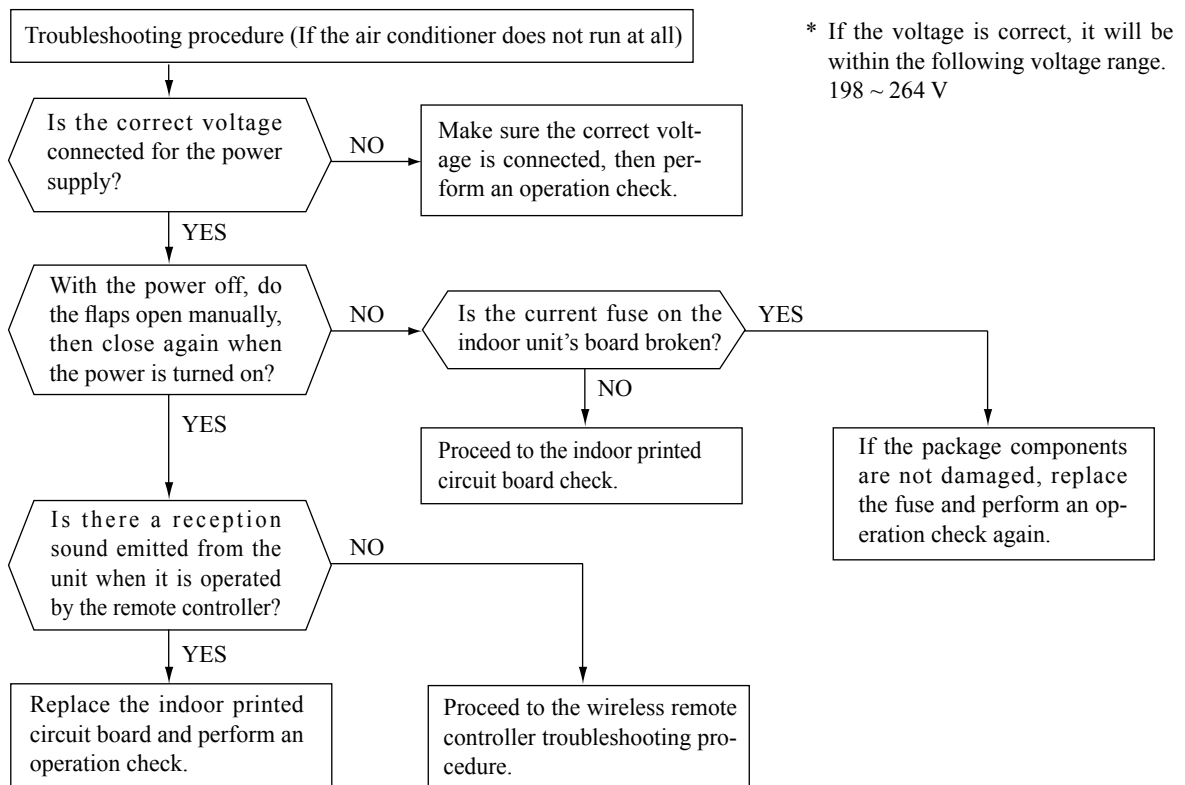

(4) Troubleshooting procedure (If the air conditioner runs)

Confirm the contents of the customer complaint.

Все каталоги и инструкции здесь: <http://splitoff.ru/tehn-doc.html>

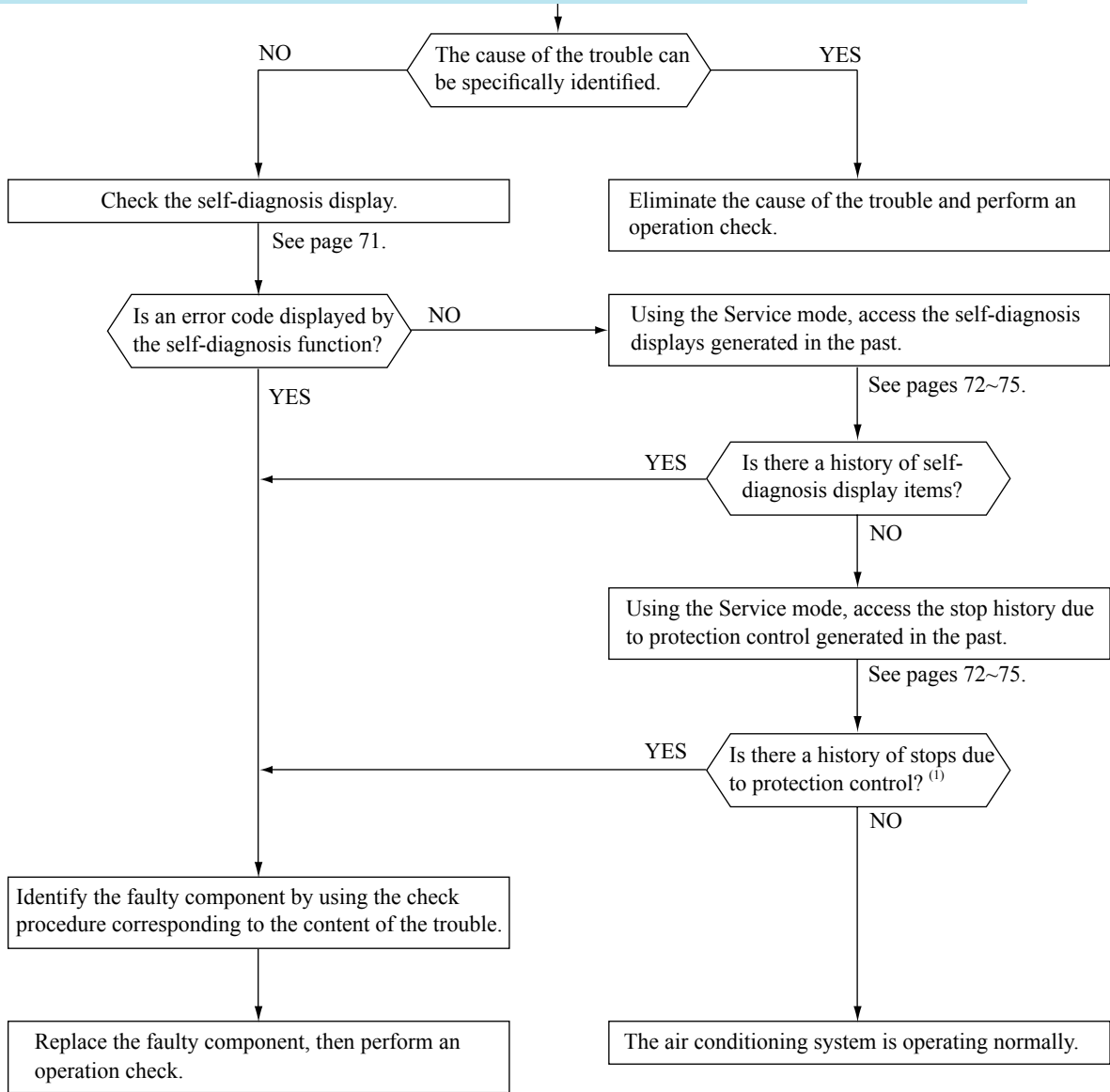

Note (1) Even in cases where only intermittent stop data are generated, the air conditioning system is normal. However, if the same protective operation recurs repeatedly (3 or more times), it will lead to customer complaints. Judge the conditions in comparison with the contents of the complaints.

(5) Self-diagnosis table

When this air conditioner performs an emergency stop, the reason why the emergency stop occurred is displayed by the flashing of display lights. If the air conditioner is operated using the remote controller 3 minutes or more after the emergency stop, the trouble display stops and the air conditioner resumes operation. ⁽¹⁾

Все каталоги и инструкции здесь: <http://splitoff.ru/tehn-doc.html>

Light	Light	---	---	---	---	---
1 time flash	ON	—	—	Heat exchanger sensor 1 error	<ul style="list-style-type: none"> Broken heat exchanger sensor 1 wire, poor connector connection Indoor PCB is faulty 	When a heat exchanger sensor 1 wire disconnection is detected while operation is stopped. (If a temperature of -28°C or lower is detected for 15 seconds, it is judged that the wire is disconnected.) (Not displayed during operation.)
2 time flash	ON	—	—	Room temperature sensor error	<ul style="list-style-type: none"> Broken room temperature sensor wire, poor connector connection Indoor PCB is faulty 	When a room temperature sensor wire disconnection is detected while operation is stopped. (If a temperature of -45°C or lower is detected for 15 seconds, it is judged that the wire is disconnected.) (Not displayed during operation.)
3 time flash	ON	—	—	Heat exchanger sensor 2 error	<ul style="list-style-type: none"> Broken heat exchanger sensor 2 wire, poor connector connection Indoor PCB is faulty 	When a heat exchanger sensor 2 wire disconnection is detected while operation is stopped. (If a temperature of -28°C or lower is detected for 15 seconds, it is judged that the wire is disconnected.) (Not displayed during operation.)
6 time flash	ON	—	E 16	Indoor fan motor error	<ul style="list-style-type: none"> Defective fan motor, poor connector connection 	When conditions for turning the indoor unit's fan motor on exist during air conditioner operation, an indoor unit fan motor speed of 300 (SRF : 150) rpm or lower is measured for 30 seconds or longer. (The air conditioner stops.)
Keeps flashing	1 time flash	8 time flash	E 38	Outdoor air temperature sensor error	<ul style="list-style-type: none"> Broken outdoor air temp. sensor wire, poor connector connection Outdoor PCB is faulty 	-55°C or lower is detected for 5 seconds continuously 3 times within 40 minutes after initial detection of this anomalous temperature. Or -55°C or higher is detected for 5 seconds continuously within 20 seconds after compressor ON. (The compressor is stopped.)
Keeps flashing	2 time flash	8 time flash	E 37	Outdoor heat exchanger sensor error	<ul style="list-style-type: none"> Broken heat exchanger sensor wire, poor connector connection Outdoor PCB is faulty 	-55°C or lower is detected for 5 seconds continuously 3 times within 40 minutes after initial detection of this anomalous temperature. Or -55°C or higher is detected for 5 seconds continuously within 20 seconds after compressor ON. (The compressor is stopped.)
Keeps flashing	4 time flash	8 time flash	E 39	Discharge pipe sensor error	<ul style="list-style-type: none"> Broken discharge pipe sensor wire, poor connector connection Outdoor PCB is faulty 	-25°C or lower is detected for 5 seconds continuously 3 times within 40 minutes after initial detection of this anomalous temperature. (The compressor is stopped.)
ON	1 time flash	1 time flash	E 42	Current cut	<ul style="list-style-type: none"> Compressor locking, open phase on compressor output, short circuit on power transistor, service valve is closed 	The compressor output current exceeds the set value during compressor start. (The air conditioner stops.)
ON	2 time flash	2 time flash	E 59	Trouble of outdoor unit	<ul style="list-style-type: none"> Broken compressor wire Compressor blockage 	When there is an emergency stop caused by trouble in the outdoor unit, or the input current value is found to be lower than the set value. (The air conditioner stops.)
ON	3 time flash	3 time flash	E 58	Current safe stop	<ul style="list-style-type: none"> Overload operation Overcharge Compressor locking 	When the compressor command speed is lower than the set value and the current safe has operated. (the compressor stops)
ON	4 time flash	1 time flash	E 51	Power transistor error	<ul style="list-style-type: none"> Broken power transistor 	When the power transistor is judged breakdown while compressor starts. (The compressor is stopped.)
ON	5 time flash	5 time flash	E 36	Over heat of compressor	<ul style="list-style-type: none"> Gas shortage, defective discharge pipe sensor, service valve is closed 	When the value of the discharge pipe sensor exceeds the set value. (The air conditioner stops.)
ON	6 time flash	6 time flash	E 5	Error of signal transmission	<ul style="list-style-type: none"> Defective power supply, Broken signal wire, defective indoor/outdoor PCB 	When there is no signal between the indoor PCB and outdoor PCB for 10 seconds or longer (when the power is turned on), or when there is no signal for 7 minute 35 seconds or longer (during operation)(the compressor is stopped).
ON	7 time flash	ON	E 48	Outdoor fan motor error	<ul style="list-style-type: none"> Defective fan motor, poor connector connection 	When the outdoor unit's fan motor speed continues for 30 seconds or longer at 75 rpm or lower. (3 times) (The air conditioner stops.)
ON	Keeps flashing	2 time flash	E 35	Cooling high pressure protecton	<ul style="list-style-type: none"> Overload operation, overcharge Broken outdoor heat exchange sensor wire Service valve is closed 	When the value of the outdoor heat exchanger sensor exceeds the set value.
2 time flash	2 time flash	7 time flash	E 60	Rotor lock	<ul style="list-style-type: none"> Defective compressor Open phase on compressor Defective outdoor PCB 	If the compressor motor's magnetic pole positions cannot be correctly detected when the compressor starts. (The air conditioner stops.)
5 time flash	ON	2 time flash	E 47	Active filter voltage error	<ul style="list-style-type: none"> Defective active filter 	When the wrong voltage connected for the power supply. When the outdoor PCB is faulty.
7 time flash	ON	2 time flash	E 57	Refrigeration cycle system protective control	<ul style="list-style-type: none"> Service valve is closed. Refrigerant is insufficient 	When refrigeration cycle system protective control operates.
—	—	—	E 1	Error of wired remote controller wiring	<ul style="list-style-type: none"> Broken wired remote controller wire, defective indoor PCB 	The wired remote controller wire Y is open. The wired remote controller wires X and Y are reversely connected. Noise is penetrating the wired remote controller lines. The wired remote controller or indoor PCB is faulty. (The communications circuit is faulty.)

Notes (1)The air conditioner cannot be restarted using the remote controller for 3 minutes after operation stops.

(2)The wired remote controller is optional parts.

(6) Service mode (Trouble mode access function)

This air conditioner is capable of recording error displays and protective stops (service data) which have occurred in the past. If self-diagnosis displays cannot be confirmed, it is possible to get a grasp of the conditions at the time trouble occurred by checking these service data.

(a) Explanation of terms

Все каталоги и инструкции здесь: <http://splitoff.ru/tehn-doc.html>

Service mode	The service mode is the mode where service data are displayed by flashing of the display lights when the operations in item (b) below are performed with the indoor controller.
Service data	These are the contents of error displays and protective stops which occurred in the past in the air conditioner system. Error display contents and protective stop data from past anomalous operations of the air conditioner system are saved in the indoor unit controller's non-volatile memory (memory which is not erased when the power goes off). There are two types of data, self-diagnosis data and stop data, described below.
Self-diagnosis data	These are the data which display the reason why a stop occurred when an error display (self-diagnosis display) occurred in an indoor unit. Data are recorded for up to 5 previous occurrences. Data which are older than the 5th previous occurrence are erased. In addition, data on the temperature of each sensor (room temperature, indoor heat exchanger, outdoor heat exchanger, outdoor air temperature, discharge pipe), remote controller information (operation switching, fan speed switching) are recorded when trouble occurs, so more detailed information can be checked.
Stop data	These are the data which display the reason by a stop occurred when the air conditioning system performed protective stops, etc. in the past. Even if stop data alone are generated, the system restarts automatically. (After executing the stop mode while the display is normal, the system restarts automatically.) Data for up to 10 previous occasions are stored. Data older than the 10th previous occasion are erased. (Important) In cases where transient stop data only are generated, the air conditioner system may still be normal. However, if the same protective stop occurs frequently (3 or more times), it could lead to customer complaints.

(b) Service mode display procedure

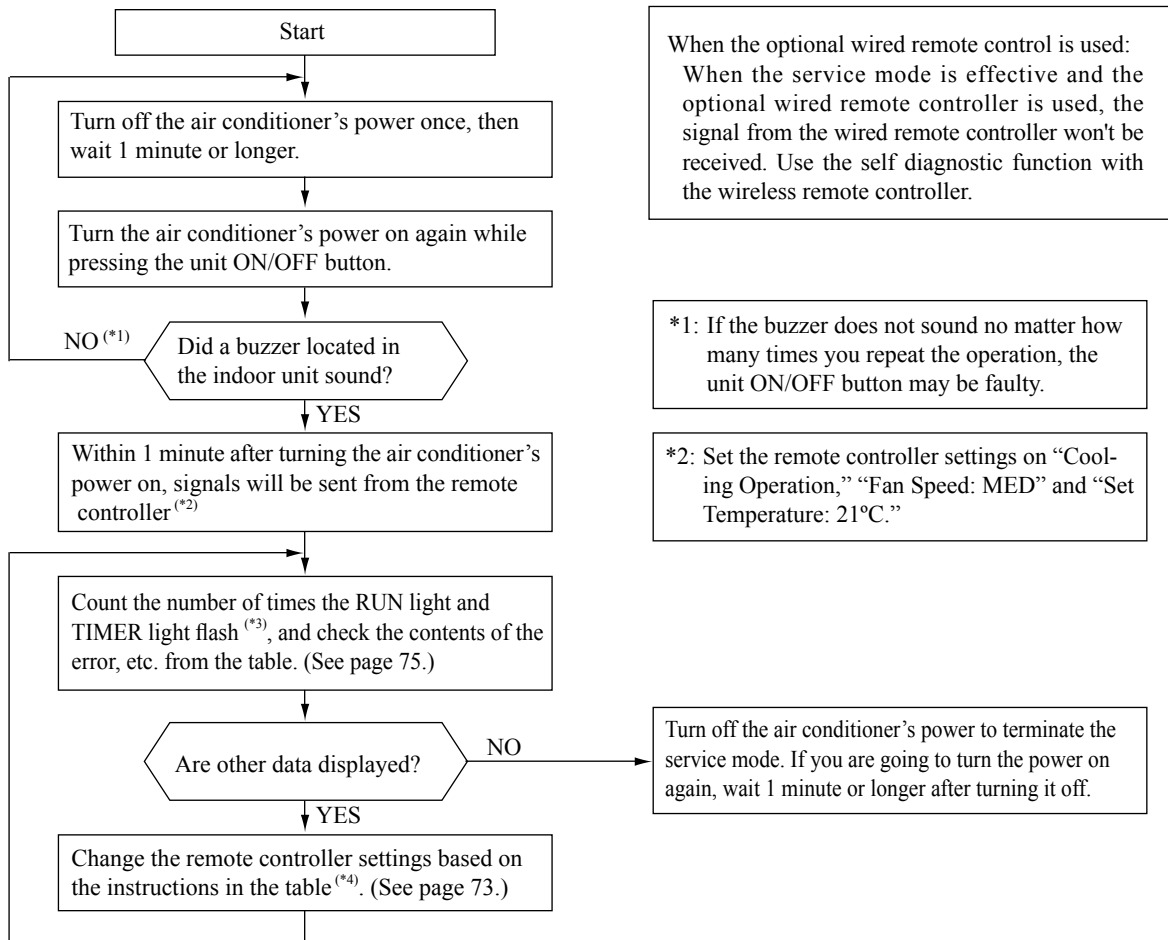

*3: To count the number of flashes in the service mode, count the number of flashes after the light lights up for 1.5 second initially (start signal). (The time that the light lights up for 1.5 second (start signal) is not counted in the number of flashes.)

* In the case of current cut (example: stop code "47")

Все каталоги и инструкции здесь: <http://splitoff.ru/tehn-doc.html>

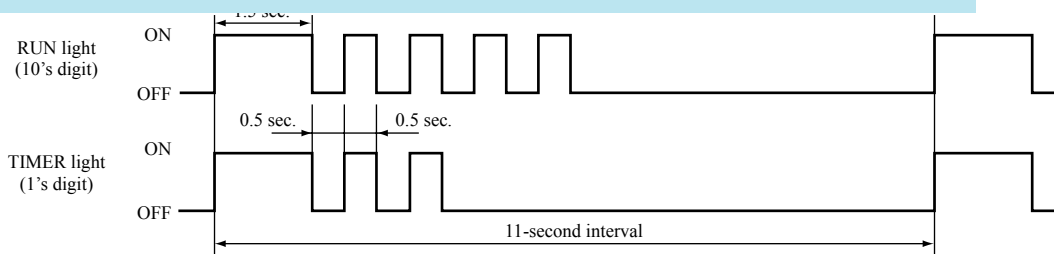

*4: When in the service mode, when the remote controller settings (operation switching, fan speed switching, temperature setting) are set as shown in the following table and sent to the air conditioner unit, the unit switches to display of service data.

1) Self-diagnosis data

What are Self-These are control data (reasons for stops, temperature at each sensor, remote controller information) diagnosis Data? from the time when there were error displays (abnormal stops) in the indoor unit in the past.

Data from up to 5 previous occasions are stored in memory. Data older than the 5th previous occasion are erased.

The temperature setting indicates how many occasions previous to the present setting the error display data are and the operation switching and fan speed switching data show the type of data.

Remote controller setting		Contents of output data
Operation switching	Fan speed switching	
Cooling	MED	Displays the reason for stopping display in the past (error code).
	HI	Displays the room temperature sensor temperature at the time the error code was displayed in the past.
	AUTO	Displays the indoor heat exchanger sensor temperature at the time the error code was displayed in the past.
Heating	LO	Displays the remote controller information at the time the error code was displayed in the past.
	MED	Displays the outdoor air temperature sensor temperature at the time the error code was displayed in the past.
	HI	Displays the outdoor heat exchanger sensor temperature at the time the error code was displayed in the past.
	AUTO	Displays the discharge pipe sensor temperature at the time the error code was displayed in the past.

Remote controller setting	Indicates the number of occasions previous to the present the error display data are from.
Temperature setting	
21°C	1 time previous (previous time)
22°C	2 times previous
23°C	3 times previous
24°C	4 times previous
25°C	5 times previous

Only for indoor heat exchanger sensor 2

Remote controller setting	Indicates the number of occasions previous to the present the error display data are from.
Temperature setting	
26°C	1 time previous (previous time)
27°C	2 times previous
28°C	3 times previous
29°C	4 times previous
30°C	5 times previous

(Example)

Remote controller setting			Displayed data
Operation switching	Fan speed switching	Temperature setting	
Все каталоги и инструкции здесь: http://splitoff.ru/tehn-doc.html			error was displayed.
		22°C	Displays the reason for the stop (error code) 2 times previous when an error was displayed.
		23°C	Displays the reason for the stop (error code) 3 times previous when an error was displayed.
		24°C	Displays the reason for the stop (error code) 4 times previous when an error was displayed.
		25°C	Displays the reason for the stop (error code) 5 times previous when an error was displayed.

2) Stop data

Remote controller setting			Displayed data
Operation switching	Fan speed switching	Temperature setting	
Cooling	LO	21°C	Displays the reason for the stop (stop code) the previous time when the air conditioner was stopped by protective stop control.
		22°C	Displays the reason for the stop (stop code) 2 times previous when the air conditioner was stopped by protective stop control.
		23°C	Displays the reason for the stop (stop code) 3 times previous when the air conditioner was stopped by protective stop control.
		24°C	Displays the reason for the stop (stop code) 4 times previous when the air conditioner was stopped by protective stop control.
		25°C	Displays the reason for the stop (stop code) 5 times previous when the air conditioner was stopped by protective stop control.
		26°C	Displays the reason for the stop (stop code) 6 times previous when the air conditioner was stopped by protective stop control.
		27°C	Displays the reason for the stop (stop code) 7 times previous when the air conditioner was stopped by protective stop control.
		28°C	Displays the reason for the stop (stop code) 8 times previous when the air conditioner was stopped by protective stop control.
		29°C	Displays the reason for the stop (stop code) 9 times previous when the air conditioner was stopped by protective stop control.
		30°C	Displays the reason for the stop (stop code) 10 times previous when the air conditioner was stopped by protective stop control.

(c) **Error code, stop code table** (Assignment of error codes and stop codes is done in common for all models.)

Number of flashes when in service mode		Stop code or Error code	Error content	Cause	Occurrence conditions	Error display	Auto recovery
RUN light (10's digit)	TIMER light (1's digit)						
Все каталоги и инструкции здесь: http://splitoff.ru/tehn-doc.html							
	flash		seconds (if communications have recovered)	Power supply cables and signal lines are improperly wired. Indoor or outdoor PCB are faulty.	communications signals from either the outdoor unit or the indoor unit being detected correctly.	○	—
3 time flash	5 time flash	35	Cooling high pressure control	Cooling overload operation. Outdoor unit fan speed drops. Outdoor heat exchanger sensor is short circuit.	When the outdoor heat exchanger sensor's value exceeds the set value.	○ (5 times)	○
	6 time flash	36	Compressor overheat 110°C (model 50 , 60 : 115°C)	Refrigerant is insufficient. Discharge pipe sensor is faulty. Service valve is closed.	When the discharge pipe sensor's value exceeds the set value.	○ (2 times)	○
	7 time flash	37	Outdoor heat exchanger sensor is abnormal	Outdoor heat exchanger sensor wire is disconnected. Connector connections are poor. Outdoor PCB is faulty.	-55°C or lower is detected for 5 seconds continuously 3 times within 40 minutes after initial detection of this anomalous temperature. Or -55°C higher is detected for 5 seconds continuously within 20 seconds after compressor ON.	○ (3 times)	○
	8 time flash	38	Outdoor air temperature sensor is abnormal	Outdoor air temperature sensor wire is disconnected. Connector connections are poor. Outdoor PCB is faulty.	-55°C or lower is detected for 5 seconds continuously 3 times within 40 minutes after initial detection of this anomalous temperature. Or -55°C higher is detected for 5 seconds continuously within 20 seconds after compressor ON.	○ (3 times)	○
	9 time flash	39	Discharge pipe sensor is abnormal (anomalous stop)	Discharge pipe sensor wire is disconnected. Connector connections are poor. Outdoor PCB is faulty.	-25°C or lower is detected for 5 seconds continuously 3 times within 40 minutes after initial detection of this anomalous temperature.	○ (3 times)	○
4 time flash	2 time flash	42	Current cut	Compressor lock. Compressor wiring short circuit. Compressor output is open phase. Outdoor PCB is faulty. Service valve is closed. Electronic expansion valve is faulty. Compressor is faulty.	Compressor start fails 42 times in succession and the reason for the final failure is current cut.	○ (2 times)	○
	7 time flash	47	Active filter voltage error	Defective active filter.	When the wrong voltage connected for the power supply. When the outdoor PCB is faulty.	○	—
	8 time flash	48	Outdoor unit's fan motor is abnormal	Outdoor fan motor is faulty. Connector connections are poor. Outdoor PCB is faulty.	When a fan speed of 75 rpm or lower continues for 30 seconds or longer.	○ (3 times)	○
5 time flash	1 time flash	51	Short circuit in the power transistor (high side) Current cut circuit breakdown	Outdoor PCB is faulty. Power transistor is damaged.	When it is judged that the power transistor was damaged at the time the compressor started.	○	—
	3 time flash	53	Suction pipe sensor is abnormal (Multi system only)	Suction pipe sensor wire is disconnected. Connector connections are poor. Outdoor PCB is faulty.	-55°C or lower is detected for 5 seconds continuously 3 times within 40 minutes after initial detection of this anomalous temperature. Or -55°C higher is detected for 5 seconds continuously within 20 seconds after compressor ON.	○ (3 times)	○
	7 time flash	57	Refrigeration cycle system protective control	Service valve is closed. Refrigerant is insufficient.	When refrigeration cycle system protective control operates.	○ (3 times)	○
	8 time flash	58	Current safe	Refrigerant is overcharge. Compressor lock. Overload operation.	When there is a current safe stop during operation.	—	○
	9 time flash	59	Compressor wiring is unconnection Voltage drop Low speed protective control	Compressor wiring is disconnected. Power transistor is damaged. Power supply construction is defective. Outdoor PCB is faulty. Compressor is faulty.	When the current is 1A or less at the time the compressor started. When the power supply voltage drops during operation. When the outdoor unit's speed is lower than 32 rps for 60 minutes.	○	○
6 time flash	OFF	60	Rotor lock	Compressor is faulty. Compressor output is open phase. Electronic expansion valve is faulty. Overload operation. Outdoor PCB is faulty.	After the compressor starts, when the compressor stops due to rotor lock.	○ (2 times)	○
	1 time flash	61	Connection lines between the indoor and outdoor units are faulty	Connection lines are faulty. Indoor or outdoor PCB are faulty.	When 10 seconds passes after the power is turned on without communications signals from the indoor or outdoor unit being detected correctly.	○	—
	2 time flash	62	Serial transmission error	Indoor or outdoor PCB are faulty. Noise is causing faulty operation.	When 7 minute 35 seconds passes without communications signals from either the outdoor unit or the indoor unit being detected correctly.	○	—
8 time flash	OFF	80	Indoor unit's fan motor is abnormal	Indoor fan motor is faulty. Connector connections are poor. Indoor PCB is faulty.	When the indoor unit's fan motor is detected to be running at 300 (SRF : 150) rpm or lower speed with the fan motor in the ON condition while the air conditioner is running.	○	—
	2 time flash	82	Indoor heat exchanger sensor is abnormal (anomalous stop)	Indoor heat exchanger sensor wire is disconnected. Connector connections are poor.	When a temperature of -28°C or lower is sensed continuously for 40 minutes during heating operation. (the compressor stops).	○	—
	4 time flash	84	Anti-condensation control	High humidity condition. Humidity sensor is faulty.	Anti-condensation prevention control is operating.	—	○
	5 time flash	85	Anti-frost control	Indoor unit fan speed drops. Indoor heat exchanger sensor is broken wire.	When the anti-frost control operates and the compressor stops during cooling operation.	—	○
	6 time flash	86	Heating high pressure control	Heating overload operation. Indoor unit fan speed drops. Indoor heat exchanger sensor is short circuit.	When high pressure control operates during heating operation and the compressor stops.	—	○

Note (1) The number of flashes when in the Service Mode do not include the 1.5 second period when the lights light up at first (starting signal). (See the example shown below.)

* In the case of current cut (example: stop code "42")
 The RUN light (10's digit) flashes 4 times and the TIMER light (1's digit) flashes 2 times.
 $4 \times 10 + 2 \times 1 = 42$ → From the table, read the instructions for error code 42, "Current cut".

Все каталоги и инструкции здесь: <http://splitoff.ru/tehn-doc.html>

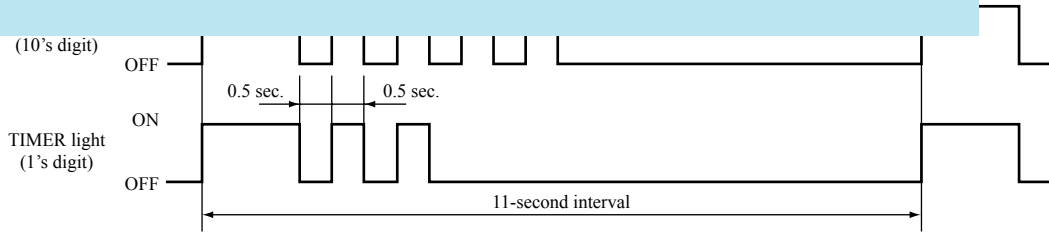

- (2) Error display: – Is not displayed. (automatic recovery only)
 ○ Displayed.
 If there is a () displayed, the error display shows the number of times that an auto recovery occurred for the same reason has reached the number of times in ().
 If no () is displayed, the error display shows that the trouble has occurred once.
- (3) Auto Recovery: – Does not occur
 ○ Auto recovery occurs.

(d) Remote controller information tables

1) Operation switching

Display pattern when in service mode	Operation switching when there is an abnormal stop
RUN light (Operation switching)	
0	AUTO
1	DRY
2	COOL
3	FAN
4	HEAT

2) Fan speed switching

Display pattern when in service mode	Fan speed switching when there is an abnormal stop
TIMER light (Fan speed switching)	
0	AUTO
2	HI
3	MED
4	LO
6	HI POWER
7	ECONO

* If no data are recorded (error code is normal), the information display in the remote controller becomes as follows.

Remote controller setting	Display when error code is normal.
Operation switching	AUTO
Fan speed switching	AUTO

(Example): Operation switching, fan speed switching, cooling HI

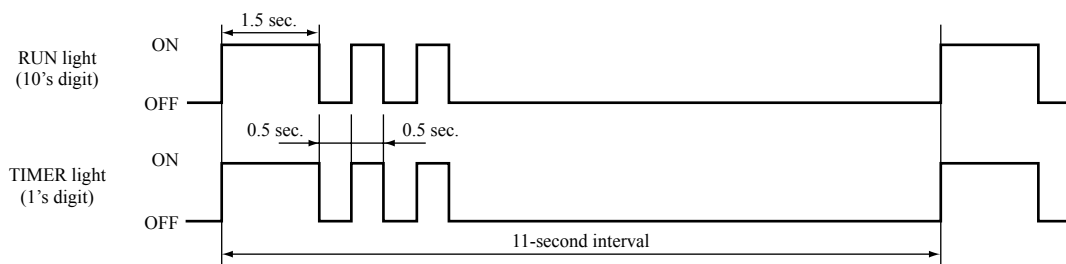

(e) Room temperature sensor, indoor heat exchanger sensor, outdoor air temperature sensor, outdoor heat exchanger sensor table

Units: °C

Все каталоги и инструкции здесь: <http://splitoff.ru/tehn-doc.html>

		TIMER light									
		0	1	2	3	4	5	6	7	8	9
(10's digit)											
Buzzer sound	(10's digit)										
Yes (sounds for 0.1 second)	6	-60	-61	-62	-63	-64					
	5	-50	-51	-52	-53	-54	-55	-56	-57	-58	-59
	4	-40	-41	-42	-43	-44	-45	-46	-47	-48	-49
	3	-30	-31	-32	-33	-34	-35	-36	-37	-38	-39
	2	-20	-21	-22	-23	-24	-25	-26	-27	-28	-29
	1	-10	-11	-12	-13	-14	-15	-16	-17	-18	-19
	0	/	-1	-2	-3	-4	-5	-6	-7	-8	-9
No (does not sound)	0	0	1	2	3	4	5	6	7	8	9
	1	10	11	12	13	14	15	16	17	18	19
	2	20	21	22	23	24	25	26	27	28	29
	3	30	31	32	33	34	35	36	37	38	39
	4	40	41	42	43	44	45	46	47	48	49
	5	50	51	52	53	54	55	56	57	58	59
	6	60	61	62	63	64	65	66	67	68	69
	7	70	71	72	73	74	75	76	77	78	79
	8	80	81	82	83	84	85	86	87	88	89
	9	90	91	92	93	94	95	96	97	98	99

* If no data are recorded (error code is normal), the display for each sensor becomes as shown below.

Sensor name	Sensor value displayed when the error code is normal
Room temperature sensor	-64°C
Indoor heat exchanger sensor	-64°C
Outdoor air temperature sensor	-64°C
Outdoor heat exchanger sensor	-64°C

(Example) Room temperature, indoor heat exchanger, outdoor air temperature, outdoor heat exchanger: "-9°C"

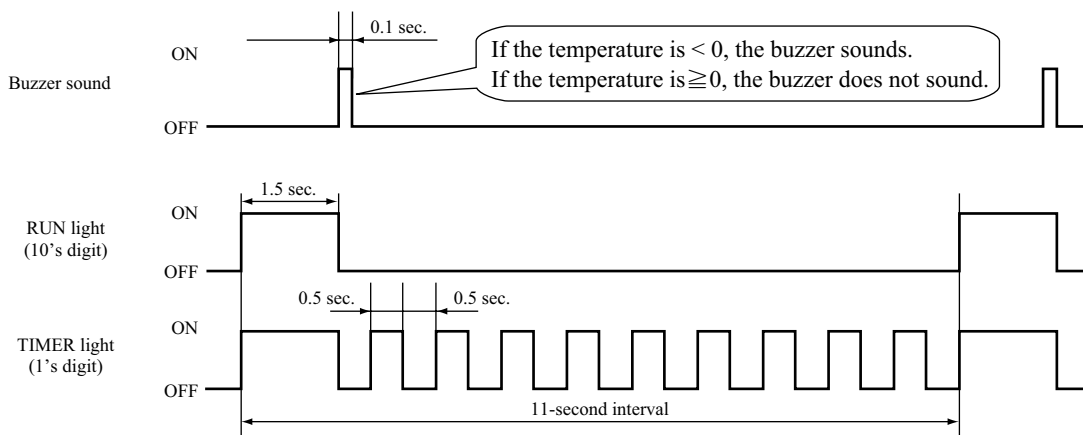

Service data record form

Customer		Model	
Date of investigation			
Machine name			

Все каталоги и инструкции здесь: <http://splitoff.ru/tehn-doc.html>

temperature setting	Operation switching	rain specu switching		BUZZER (1CS/NO.)	FAU/N light (TIMES)	L1MER light (TIMES)	Display content
21	Cooling	MED	Error code on previous occasion.	/			
		HI	Room temperature sensor on previous occasion.				
		AUTO	Indoor heat exchanger sensor 1 on previous occasion.				
	Heating	LO	Remote controller information on previous occasion.	/			
		MED	Outdoor air temperature sensor on previous occasion.				
		HI	Outdoor heat exchanger sensor on previous occasion.				
	AUTO	Discharge pipe sensor on previous occasion.					
26	Cooling	AUTO	Indoor heat exchanger sensor 2 on previous occasion.				
22	Cooling	MED	Error code on second previous occasion.	/			
		HI	Room temperature sensor on second previous occasion.				
		AUTO	Indoor heat exchanger sensor 1 on second previous occasion.				
	Heating	LO	Remote controller information on second previous occasion.	/			
		MED	Outdoor air temperature sensor on second previous occasion.				
		HI	Outdoor heat exchanger sensor on second previous occasion.				
	AUTO	Discharge pipe sensor on second previous occasion.					
27	Cooling	AUTO	Indoor heat exchanger sensor 2 on second occasion.				
23	Cooling	MED	Error code on third previous occasion.	/			
		HI	Room temperature sensor on third previous occasion.				
		AUTO	Indoor heat exchanger sensor 1 on third previous occasion.				
	Heating	LO	Remote controller information on third previous occasion.	/			
		MED	Outdoor air temperature sensor on third previous occasion.				
		HI	Outdoor heat exchanger sensor on third previous occasion.				
	AUTO	Discharge pipe sensor on third previous occasion.					
28	Cooling	AUTO	Indoor heat exchanger sensor 2 on third occasion.				
24	Cooling	MED	Error code on fourth previous occasion.	/			
		HI	Room temperature sensor on fourth previous occasion.				
		AUTO	Indoor heat exchanger sensor 1 on fourth previous occasion.				
	Heating	LO	Remote controller information on fourth previous occasion.	/			
		MED	Outdoor air temperature sensor on fourth previous occasion.				
		HI	Outdoor heat exchanger sensor on fourth previous occasion.				
	AUTO	Discharge pipe sensor on fourth previous occasion.					
29	Cooling	AUTO	Indoor heat exchanger sensor 2 on fourth occasion.				
25	Cooling	MED	Error code on fifth previous occasion.	/			
		HI	Room temperature sensor on fifth previous occasion.				
		AUTO	Indoor heat exchanger sensor 1 on fifth previous occasion.				
	Heating	LO	Remote controller information on fifth previous occasion.	/			
		MED	Outdoor air temperature sensor on fifth previous occasion.				
		HI	Outdoor heat exchanger sensor on fifth previous occasion.				
	AUTO	Discharge pipe sensor on fifth previous occasion.					
30	Cooling	AUTO	Indoor heat exchanger sensor 2 on fifth occasion.				
21	Cooling	Lo	Stop code on previous occasion.				
22			Stop code on second previous occasion.				
23			Stop code on third previous occasion.				
24			Stop code on fourth previous occasion.				
25			Stop code on fifth previous occasion.				
26			Stop code on sixth previous occasion.				
27			Stop code on seventh previous occasion.				
28			Stop code on eighth previous occasion.				
29			Stop code on ninth previous occasion.				
30			Stop code on tenth previous occasion.				
Judgment							Examiner
Remarks							

Note (1) In the case of indoor heat exchanger sensor 2, match from 26 to 30 the temperature setting of remote controller. (Refer to page 73)

(7) Inspection procedures corresponding to detail of trouble

Sensor error

[Broken sensor wire, connector poor connection]

Все каталоги и инструкции здесь: <http://splitoff.ru/tehn-doc.html>

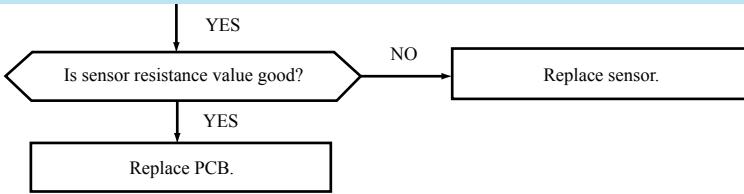

◆ Discharge pipe sensor temperature characteristics

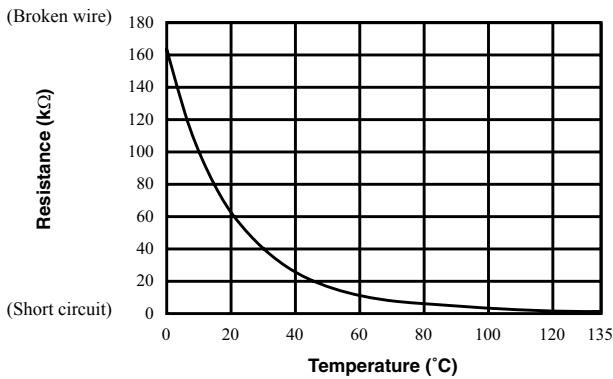

◆ Sensor temperature characteristics (Room temp., indoor heat exchanger temp., outdoor heat exchanger temp., outdoor air temp.)

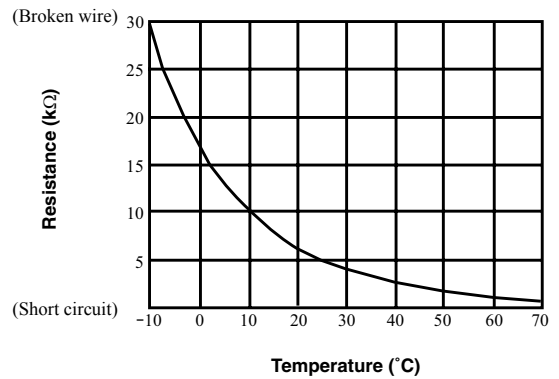

Indoor fan motor error

[Defective fan motor, connector poor connection, defective indoor PCB]

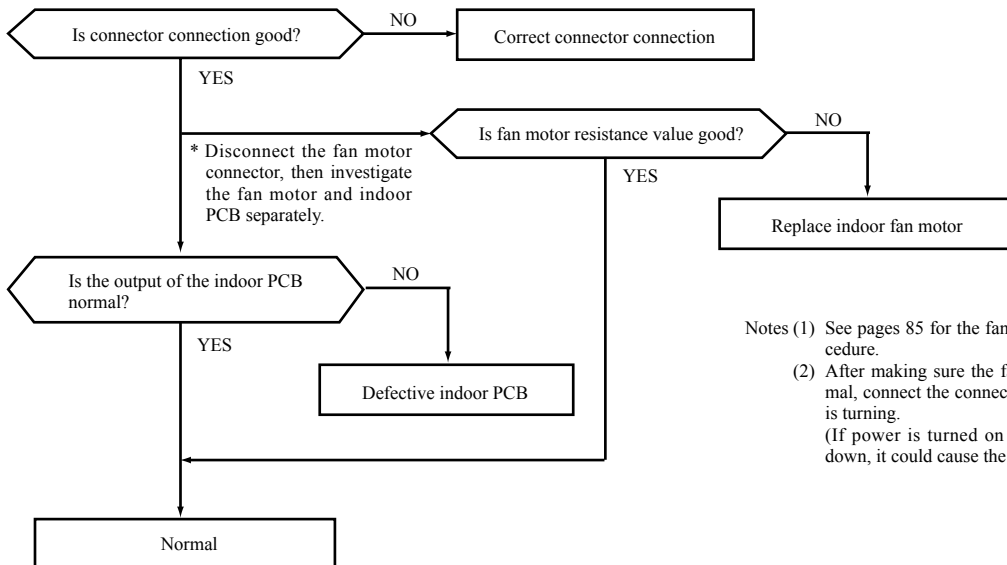

Notes (1) See pages 85 for the fan motor and indoor PCB check procedure.

(2) After making sure the fan motor and indoor PCB are normal, connect the connectors and confirm that the fan motor is turning.

(If power is turned on while one or the other is broken down, it could cause the other to break down also.)

Current cut

[Compressor lock, Compressor wiring short circuit, Compressor output is open phase, Outdoor PCB is faulty, Service valve is closed, EEV is faulty, Compressor faulty.]

Все каталоги и инструкции здесь: <http://splitoff.ru/tehn-doc.html>

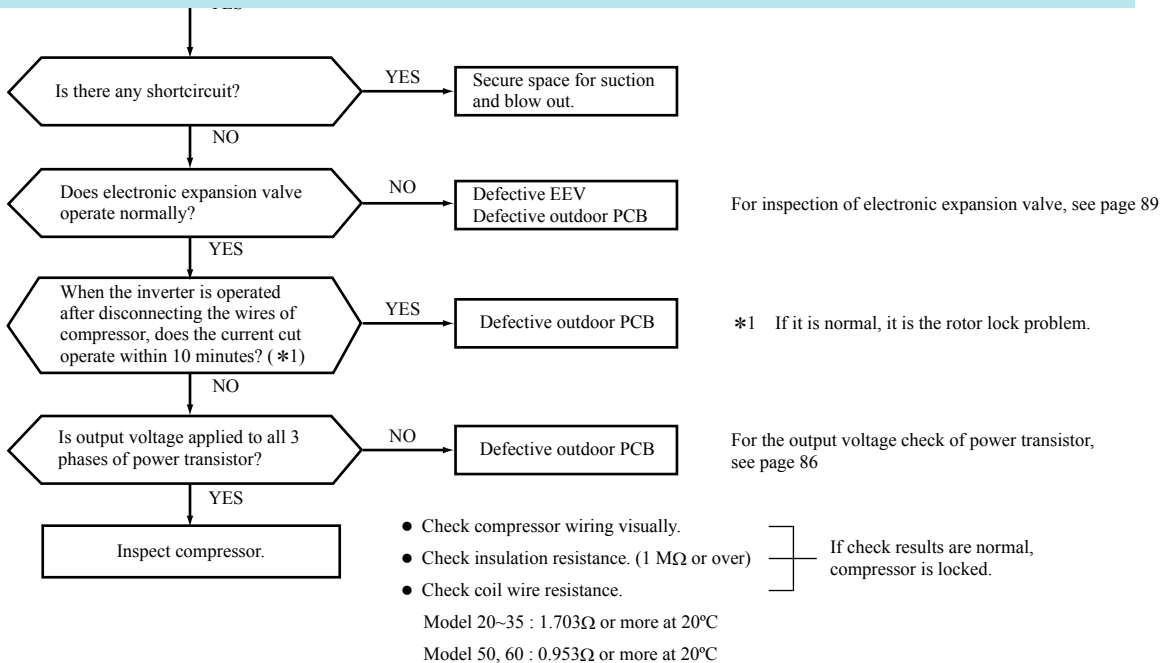

Current safe stop

[Overload operation, compressor lock, overcharge]

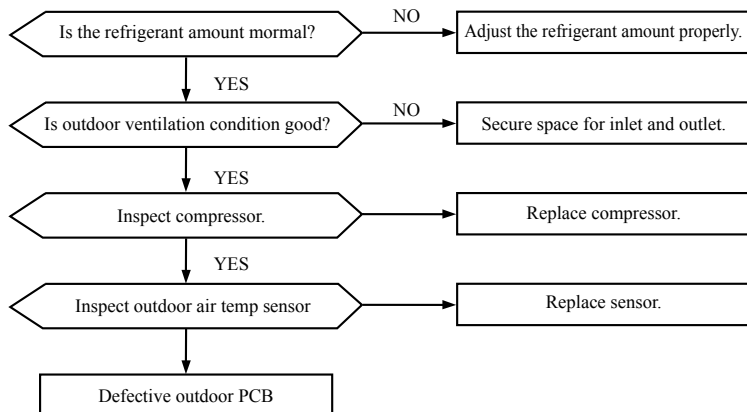

Over heat of compressor

[Gas shortage, defective discharge pipe sensor]

Все каталоги и инструкции здесь: <http://splitoff.ru/tehn-doc.html>

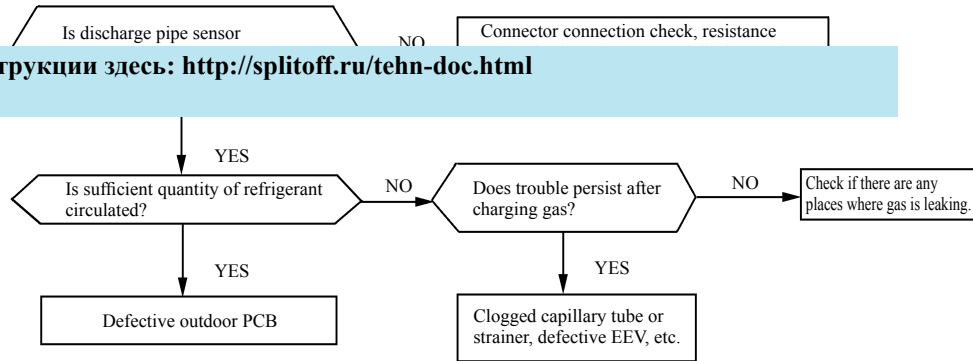

Error of signal transmission

[Wiring error including power cable, defective indoor/ outdoor PCB]

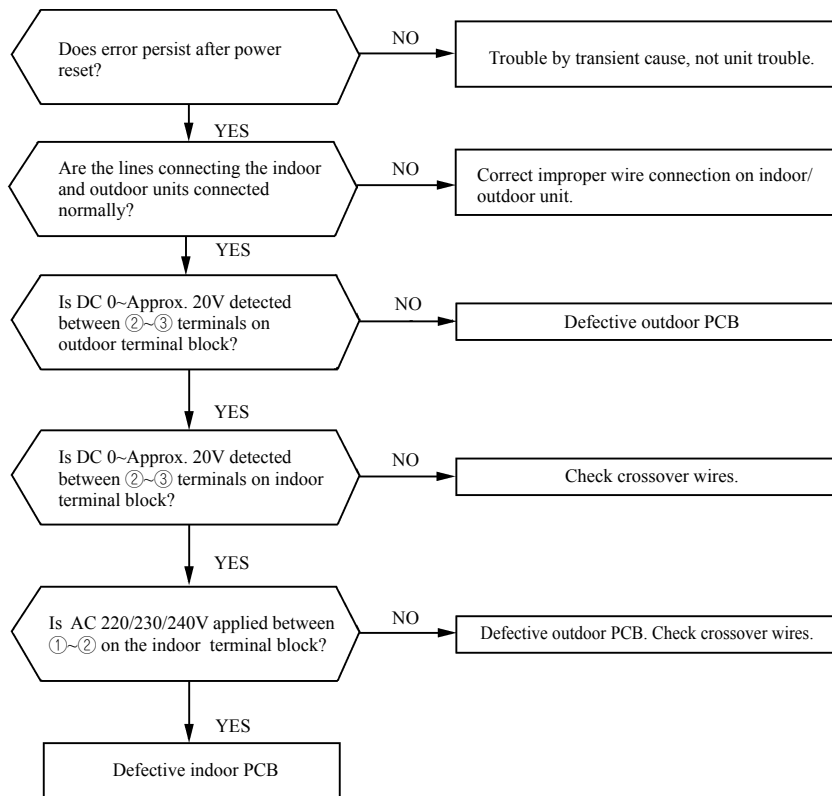

Trouble of outdoor unit

[Insufficient refrigerant amount, Faulty power transistor, Broken compressor wire]
 [Service valve close, Defective EEV, Defective outdoor PCB]

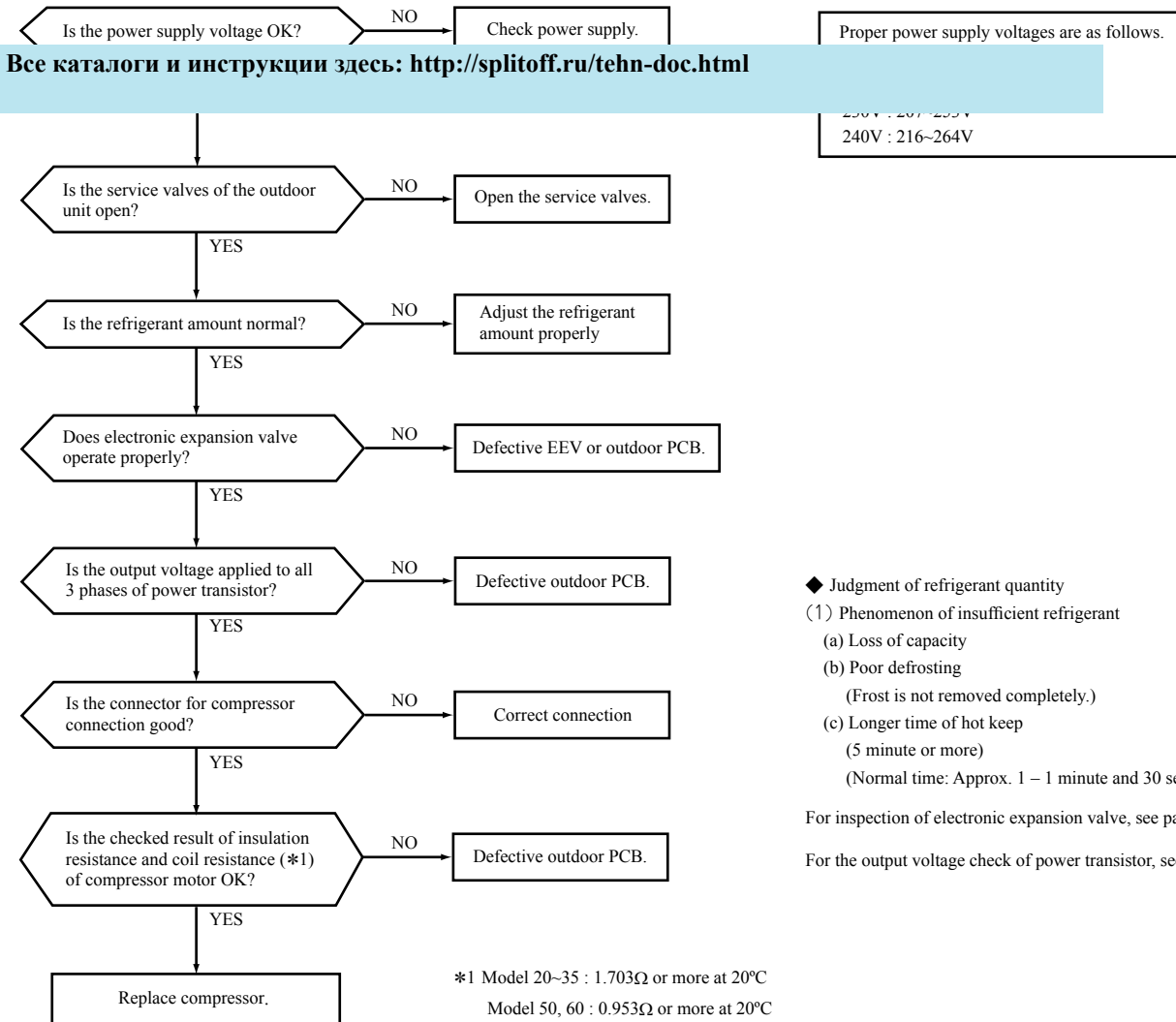

◆ Judgment of refrigerant quantity

(1) Phenomenon of insufficient refrigerant

- (a) Loss of capacity
- (b) Poor defrosting
(Frost is not removed completely.)
- (c) Longer time of hot keep
(5 minute or more)
(Normal time: Approx. 1 – 1 minute and 30 seconds)

For inspection of electronic expansion valve, see page89

For the output voltage check of power transistor, see page86

Outdoor fan motor error

[Defective fan motor, connector poor connection, defective outdoor PCB]

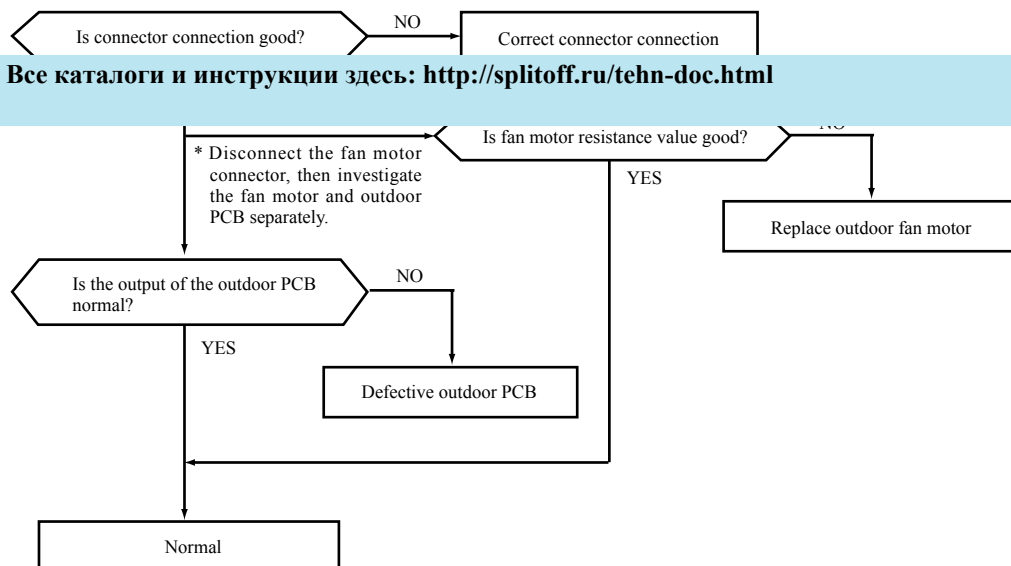

Все каталоги и инструкции здесь: <http://splitoff.ru/tehn-doc.html>

Rotor lock

[Defective compressor, defective outdoor PCB]

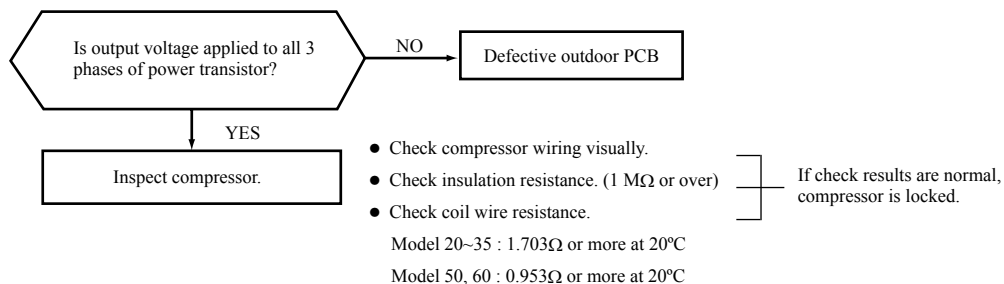

(8) Phenomenon observed after shortcircuit, wire breakage on sensor

(a) Indoor unit

Sensor	Operation mode	Phenomenon	
		Shortcircuit	Disconnected wire
Room temperature sensor	Cooling	Release of continuous compressor operation command.	Continuous compressor operation command is not released.
	Heating	Continuous compressor operation command is not released.	Release of continuous compressor operation command.
Heat exchanger sensor	Cooling	System can be operated normally.	Continuous compressor operation command is not released. (Anti-frosting)
	Heating	High pressure control mode (Compressor stop command)	Hot keep (Indoor fan stop)
Humidity sensor	Cooling	Refer to the table below.	Refer to the table below.
	Heating	Normal system operation is possible.	

■ Humidity sensor operation

Failure mode	Control input circuit resding	Air conditioning system operation
Disconnected wire	① Disconnected wire	Humidity reading is 0%
	② Disconnected wire	
	①② Disconnected wire	
Short Circuit	① and ② are shot circuited	Humidity reading is 100%

Remark: Do not perform a continuity check of the humidity sensor with a tester. If DC current is applied, it could damage the sensor.

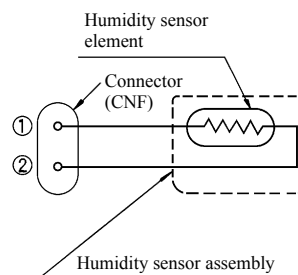

(b) Outdoor unit

Sensor	Operation mode	Phenomenon	
		Shortcircuit	Disconnected wire
Heat exchanger sensor	Cooling	System can be operated normally.	Compressor stop.
	Heating	Defrosting is not performed.	Defrosting is performed for 10 minutes at approx. 35 minutes.
Discharge pipe sensor	All modes	Compressor overload protection is disabled. (Can be operated.)	Compressor stop

Все каталоги и инструкции здесь: <http://splitoff.ru/tehn-doc.html>

(9) Checking the indoor electrical equipment

(a) Indoor PCB check procedure

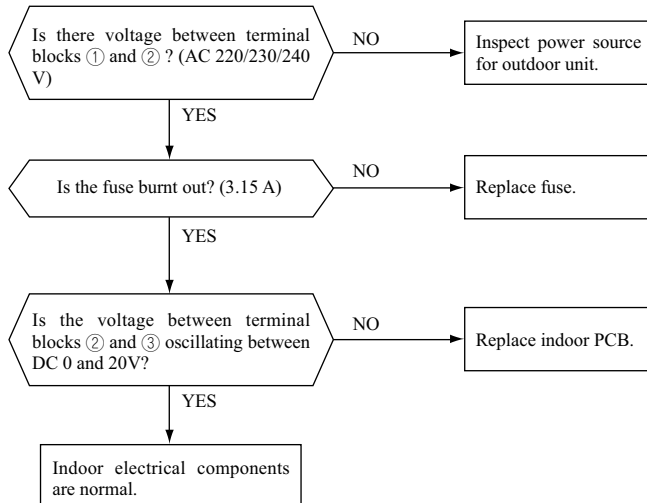

(b) Indoor unit fan motor check procedure

This is a diagnostic procedure for determining if the indoor unit's fan motor or the indoor PCB is broken down.

1) Indoor PCB output check

- Turn off the power.
- Remove the front panel, then disconnect the fan motor lead wire connector.
- Turn on the power. If the unit operates when the ON/OFF button is pressed, if trouble is detected after the voltages in the following figure are output for approximately 30 seconds, it means that the indoor PCB is normal and the fan motor is broken down.

If the voltages in the following figure are not output at connector pins No. ①, ④ and ⑤, the indoor PCB has failed and the fan motor is normal.

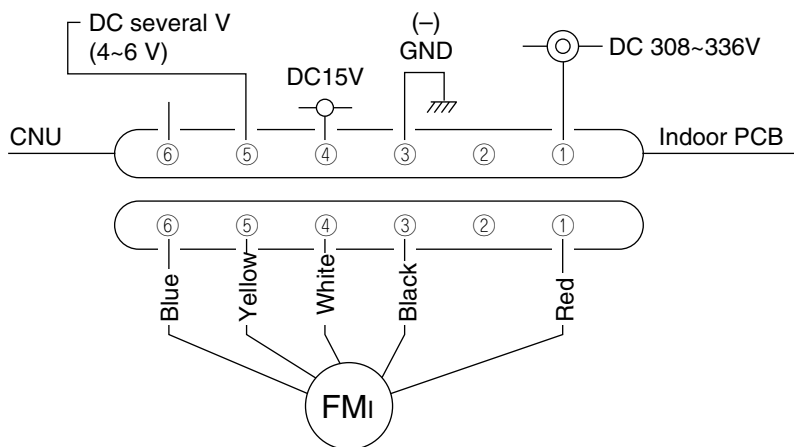

Measuring point	Resistance when normal
① - ③	DC 308~336V
④ - ③	DC 15V
⑤ - ③	DC several V (4~6V)
⑥ - ③	DC several V (4~6V)

2) Fan motor resistance check

Measuring point	Resistance when normal
① - ③ (Red - Black)	20 MΩ or higher
④ - ③ (White - Black)	20 MΩ or higher

- Notes (1) Remove the fan motor and measure it without power connected to it.
 (2) If the measured value is below the value when the motor is normal, it means that the fan motor is faulty.

(C) Power transistor inspection procedure

[Use a tester with a needle indicator for the inspection. (Do not use a digital tester. Check in the AC 300 volt range.)]

(1) If there is a self-diagnosis display, inspect the compressor system (burns, wiring mistakes, etc.) If no problems are found, check the output of the power transistor.

Все каталоги и инструкции здесь: <http://splitoff.ru/tehn-doc.html>

it board for the

outdoor unit are normal.

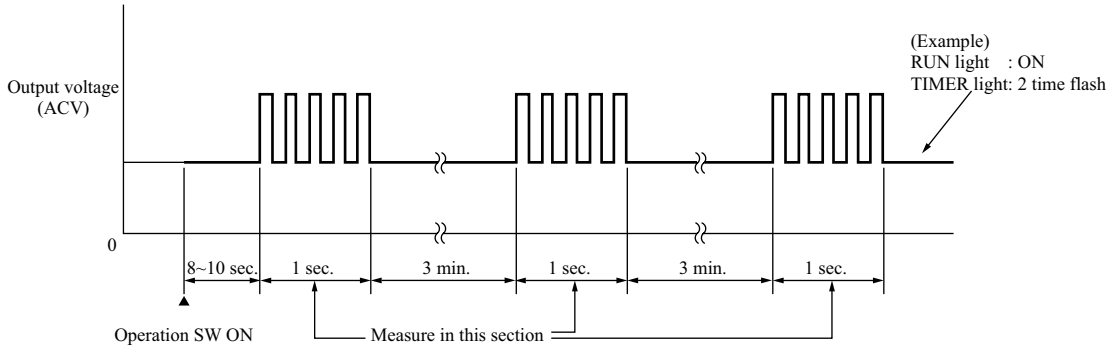

(11) How to make sure of remote controller

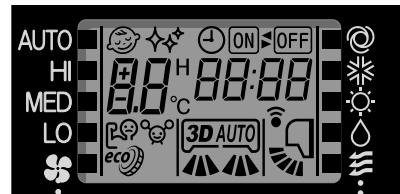
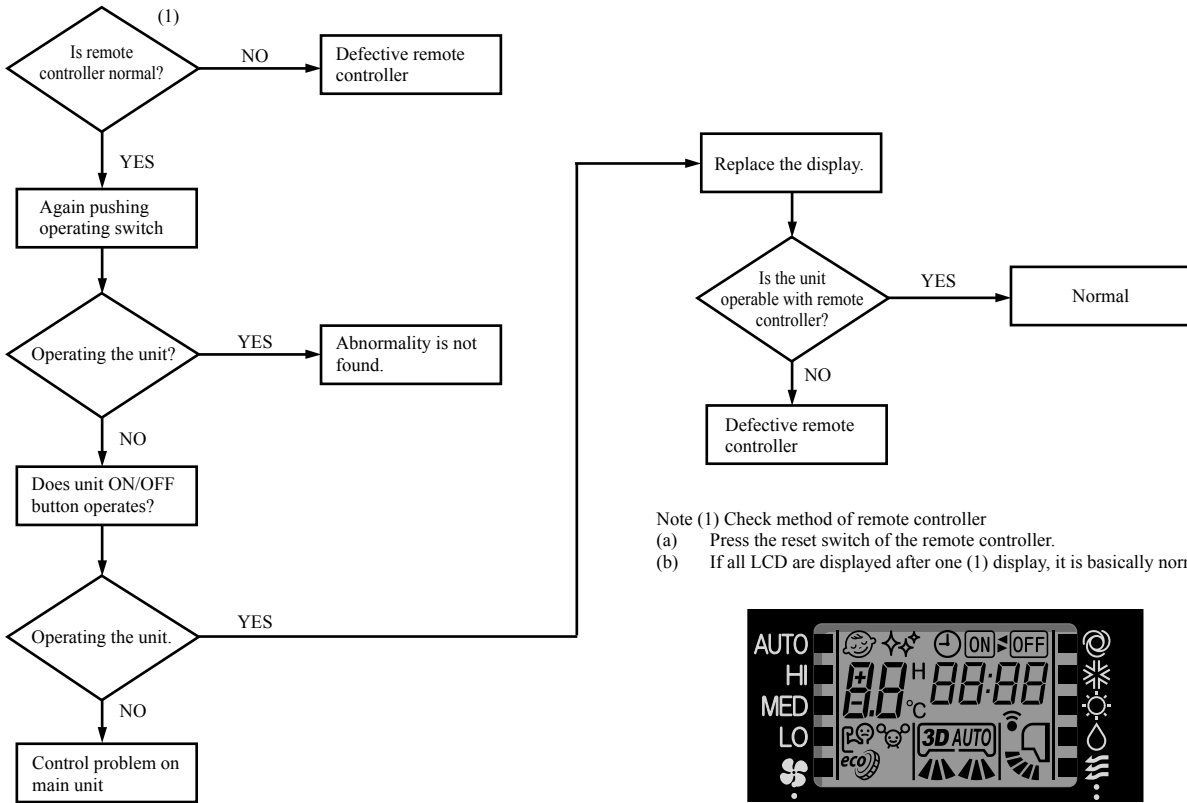

(10) Outdoor unit inspection points
Models SRC20ZIX-S,25ZIX-S,35ZIX-S

Все каталоги и инструкции здесь: <http://splitoff.ru/tehn-doc.html>

◆ Check point of outdoor unit

CAUTION – HIGH VOLTAGE

High voltage is produced in the control box. Don't touch electrical parts in the control box for 5 minutes after the unit is stopped.

Color symbol

BK	Black
OR	Orange
RD	Red
WH	White
Y	Yellow
Y/G	Yellow/Green

Power source
1 Phase
220-240V 50Hz

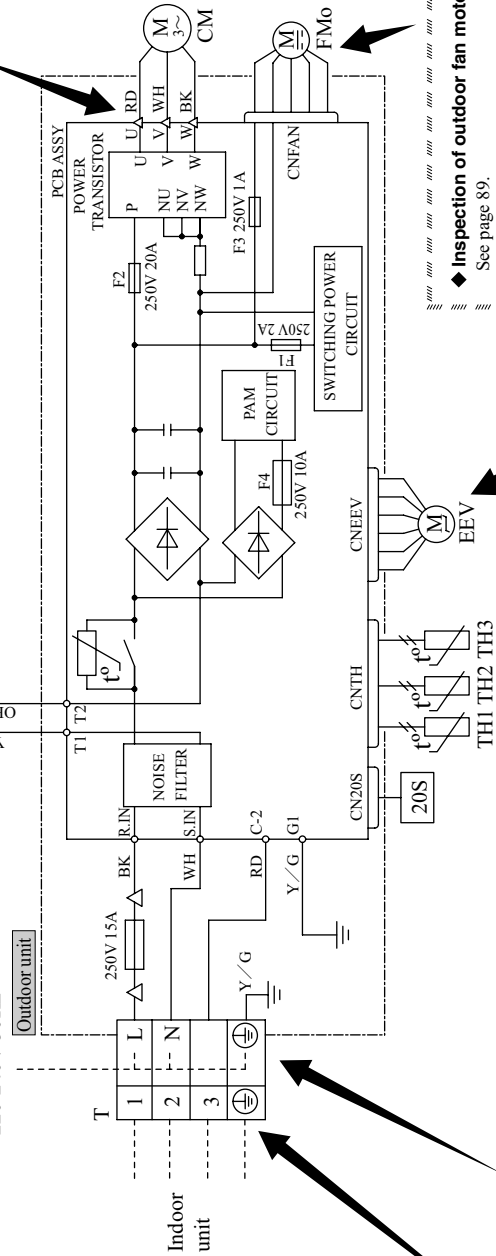

◆ Power source and serial signal inspection

- ① to ②: AC 220/230/240V
- ① to ②: AC 220/230/240V
- ② to ③: Normal if the voltage oscillates between DC 0 and approx. 20V

◆ Inspection power transistor

Remove the fasten terminal and test output voltage

◆ Inspection of outdoor fan moit

See page 89.

◆ Inspection of electronic expansion valve

See page 89.

◆ Inspection of resistance value of sensor

Remove the connector and check the resistance value. See the section of sensor characteristics on page 80.

Все каталоги и инструкции здесь: <http://splitoff.ru/tehn-doc.html>

◆ Check point of outdoor unit

CAUTION- HIGH VOLTAGE

High voltage is produced in the control box. Don't touch electrical parts in the control box for 5 minutes after the unit is stopped.

Color symbol

BK	Black
OR	Orange
RD	Red
WH	White
Y	Yellow
Y/G	Yellow/Green

◆ Inspection power transistor
Remove the fasten terminal and test output voltage.

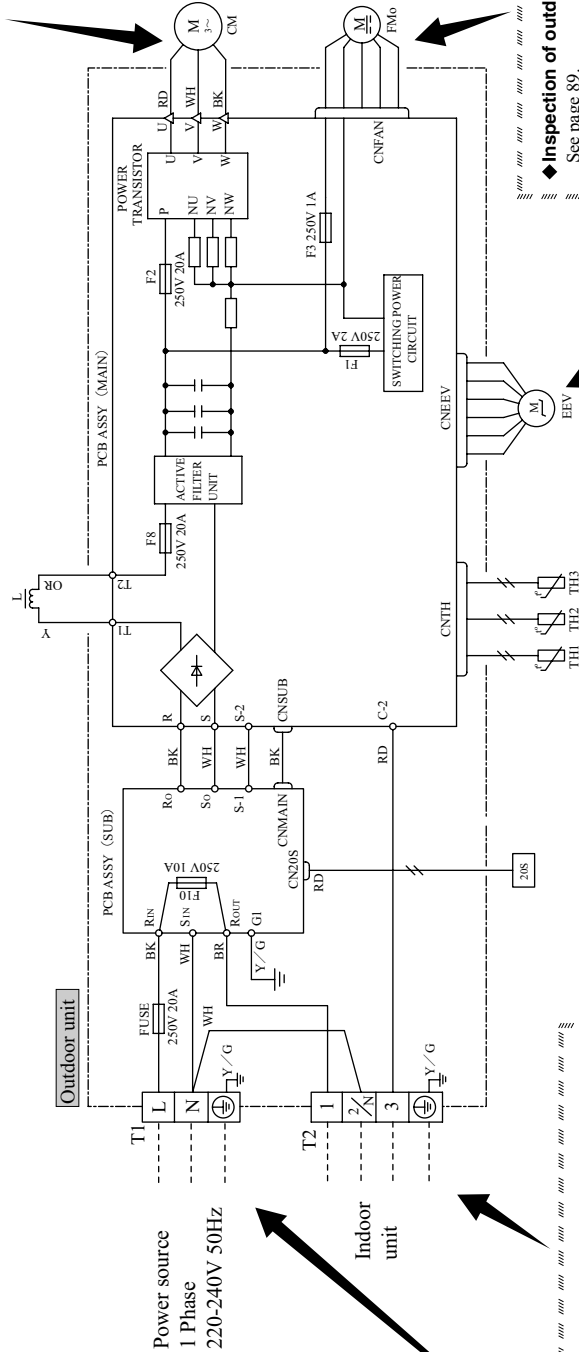

◆ Power source and serial signal inspection

- ① to ②: AC 220/230/240V
- ① to ③: AC 220/230/240V
- ② to ③: Normal if the voltage oscillates between DC 0 and approx. 20V

motor

◆ Inspection of outdoor
See page 89.

◆ Inspection of electronic expansion valve
See page 89.

◆ Inspection of resistance value of sensor
Remove the connector and check the resistance value.
See the section of sensor characteristics on page 80.

(a) Inspection of electronic expansion valve

Electronic expansion valve operates for approx. 10 seconds after the power on, in order to determine its aperture. Check the operating sound and voltage during the period of time. (Voltage cannot be checked during operation in which only the aperture change occurs.)

Все каталоги и инструкции здесь: <http://splitoff.ru/tehn-doc.html>

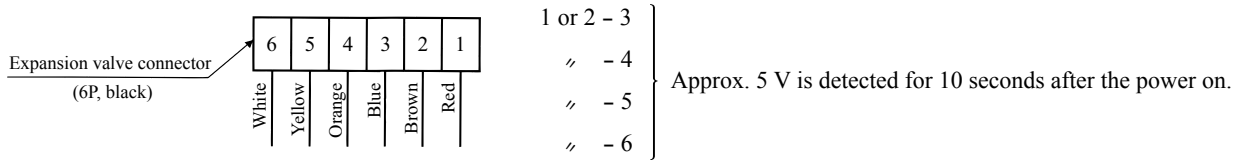

- 3) If voltage is detected, the outdoor PCB is normal.
- 4) If the expansion valve does not operate (no operating sound) while voltage is detected, the expansion valve is defective.

• Inspection of electronic expansion valve as a separate unit

Measure the resistance between terminals with an analog tester.

Measuring point	Resistance when normal
1-6	46 ± 4Ω (at 20°C)
2-4	
2-3	
2-5	

(b) Outdoor unit fan motor check procedure

- When the outdoor unit fan motor error is detected, diagnose which of the outdoor unit fan motor or outdoor PCB is defective.
- Diagnose this only after confirming that the indoor unit is normal.

(1) Outdoor PCB output check

- 1) Turn off the power.
- 2) Disconnect the outdoor unit fan motor connector CNFAN.
- 3) When the indoor unit is operated by inserting the power supply plug and pressing (ON) the backup switch for more than 5 seconds, if the voltage of pin No. ② in the following figure is output for 30 seconds at 20 seconds after turning “ON” the backup switch, the outdoor PCB is normal but the fan motor is defective.

If the voltage is not detected, the outdoor PCB is defective but the fan motor is normal.

Note (1) The voltage is output 3 times repeatedly. If it is not detected, the indoor unit displays the error message.

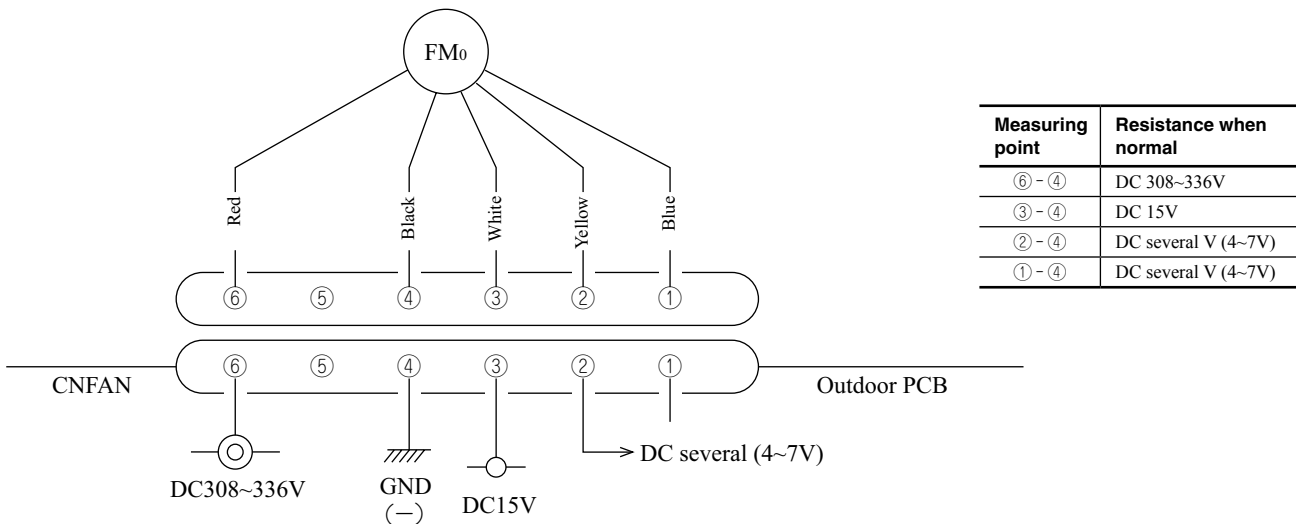

2) Fan motor resistance check

Measuring point	Resistance when normal
⑥ - ④ (Red - Black)	20 MΩ or higher
③ - ④ (White - Black)	20 MΩ or higher

- Notes (1) Remove the fan motor and measure it without power connected to it.
- (2) If the measured value is below the value when the motor is normal, it means that the fan motor is faulty.

3.2 Servicing

(1) Evacuation

The evacuation is an procedure to purge impurities.....noncondensable gas, air, moisture from the refrigerant equipment by us-

Все каталоги и инструкции здесь: <http://splitoff.ru/tehn-doc.html>

ft in the refriger-

- Evacuation procedure

- Check to ensure that there is no internal pressure in the unit. If there is an internal pressure, it should be relieved through the check joint.
- Connect the service hoses of the gauge manifold to the check joint of the gas & liquid piping.
- Connect a vacuum pump to the charge hose (A). Repeat evacuation in the following sequence.

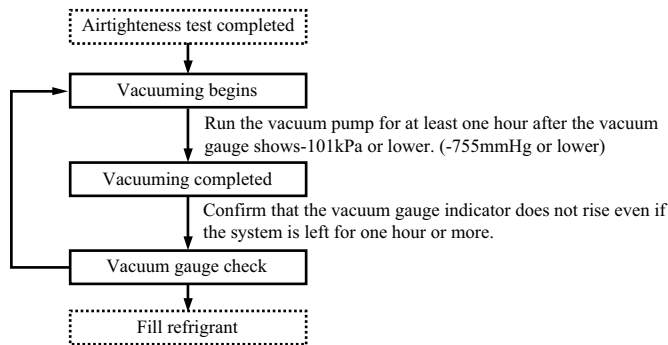

When the system has remaining moisture inside or leaky point, the vacuum gauge indicator will rise.

Check the system for a leaky point and then draw air to create a vacuum again.

- Notes
- (1) Do not use the refrigerant pressure to expel air.
 - (2) Do not use the compressor for evacuation.
 - (3) Do not operate the compressor in the vacuum condition.

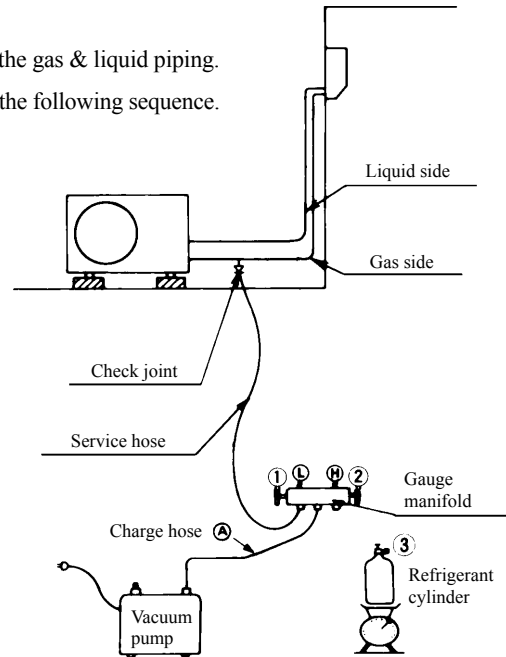

(2) Refrigerant charge

- Discharge refrigerant entirely from the unit and evacuate the unit.
Note: Addition of refrigerant without evacuation is unreasonable, because it will result in low charge or overcharge.
- Keep the gauge manifold and connect a refrigerant cylinder to the unit.
- Record the weight of the refrigerant cylinder on the balance. This is necessary for making sure of the charged refrigerant amount.
- Purge air from the charge hose (A)
Firstly loose the connecting portion of the charge hose (A) at the gauge manifold side and open the valve (3) for a few seconds, and then immediately retighten it after observing that gas is blow out from the loosened portion.
- Open the valve (1) and (3) after discharging air from the charge hose (A), then the liquid refrigerant begins flowing from the cylinder into the unit. Be sure to erect the refrigerant cylinder upright to let liquid refrigerant flow into the unit.
- When refrigerant has been charged into the system to some extent, refrigerant flow becomes stagnant, when that happens, start the compressor in cooling cycle until the unit is filled with refrigerant to the specified weight.
- Making sure of the refrigerant amount, close the valve (3)
- Disconnect the charge hose from the unit. Cover the valve ports of the refrigerant piping with caps and tighten them securely.
- Check for gas leakage applying a gas leak detector along the piping line.
- Start the air conditioner and make sure of its operating condition.....high side and low side pressures and temperature difference between return air and supply air.

4 REFRIGERANT PIPING INSTALLATION/SERVICING MANUAL FOR AIR CONDITIONERS USING R410A

(These materials are extracted from document issued by The Japan Refrigeration and

Все каталоги и инструкции здесь: <http://splitoff.ru/tehn-doc.html>

4.1.1 Refrigerant R410A

(1) Adoption of R410A in air conditioners

In 1974, it was pointed out that the ozone layer in the upper stratosphere (about 20 ~ 40 km above ground) might have been damaged by the ozone depleting substances such as CFC (chlorofluorocarbon) and HCFC (hydrochlorofluorocarbon). Since that time, many countries across the world have endeavored to take countermeasures against the ozone depletion.

As a refrigerant belonging to the HCFCs, the conventional refrigerant (R22) used in air conditioners also tends to deplete the ozone layer. Therefore, complying with the provisions of the international regulations (i.e. Montreal Protocol concerning the Ozone Depleting Substances) and national laws & Regulations concerned, it is necessary to replace R22 with other types of refrigerant which do not deplete the ozone layer.

A refrigerant composed of hydrogen (H), fluorine (F) and carbon (C), is called an HFC and does not deplete the ozone layer. One HFC's is R410A whose pressure is about 1.6 times higher than R22 and whose energy efficiency is almost comparable to that of R22 at the same refrigerant temperature.

(2) Chemical characteristics of R410A

a) Chemical stability

Like R22, R410A is a chemically stable, less toxic and non-flammable refrigerant. However, as in the case of R22, the specific gravity of its vapour is larger than that of air and should it leak in an airtight room it may stay at a low level and cause an oxygen starvation accident. It may also, should it come in direct contact with fire, cause a poisonous gas to occur, so be sure to handle it only in a well ventilated area.

b) Composition changes (Pseudo-azeotropic characteristics)

R410A is a pseudo-azeotropic mixed refrigerant composed of two constituents - R32 and R125. "Quasi-azeotropic" condition refers to a state in which the dew-point curve and boiling-point curve - gas-liquid equilibrium curves (pressure constant) - almost lie on top of each other, and a multi-constituent refrigerant having this chemical characteristic incurs less composition changes even when evaporation (or condensation) as a phase change occurs. Consequently, even when refrigerant leaks from the gas phase somewhere in the piping installation, the composition of circulated refrigerant incurs less changes.

Therefore, R410A can be treated in almost a same manner as a mono-constituent refrigerant like R22 is treated. When actually charging R410A, however, do so from the liquid phase side by taking into account the phenomenon that, when put in a cylinder, the composition changes a little between gas and liquid phases.

c) Pressure characteristics

As shown in Table 2, since R410A's vapor pressure is about 1.6 times higher than that of R22 at the same temperature, perform installation/service with special tools and materials which are exclusive for R410A and can withstand high pressure.

Table 1. Comparison of thermophysical properties of R410A and R22

	R410A	R22
Composition (wt%)	R32/R125 (50/50)	R22 (100)
Molecular weight	72.6	86.5
Boiling point (°C)	-51.4	-40.8
Vapour pressure (25°C, MPa)	1.56	0.94
Saturated vapor density (25°C, kg/m ³)	64.0	44.4
Inflammability	Nonflammable	Nonflammable
Ozone depletion potential (ODP)	0	0.055
Global warming potential (GWP)	1730	1700

Source: List of thermophysical properties compiled by the Japan society of refrigeration and air conditioning, NIST REFPROP V5.10, etc.

Table 2. Comparison of saturated vapor pressure of R410A and R22

Refrigerant Temperature (°C)	unit: MPa	
	R410A	R22
-20	0.30	0.14
0	0.70	0.40
20	1.35	0.81
40	2.32	1.43
60	3.73	2.33
65	4.15	2.60

Source: List of thermophysical properties compiled by the Japan society of refrigeration and air conditioning, NIST REFPROP V5.10, etc.

(3) Lubricating oils for R410A

As the lubricating oils for R22, mineral oils, alkylbenze synthetic oils, etc. have so far been used. As R410A features less solubility with these conventional lubricating oils such as mineral oils, the lubricating oils tend to stay within the refrigeration cycle. As the lubricating oils highly soluble with R410A, ester, ethereal and other synthetic oils are available. However, as these syn-

Все каталоги и инструкции здесь: <http://splitoff.ru/tehn-doc.html>

Furthermore, if
block the capillary

tubes, or cause the compressor to fail. So, never mix these synthetic oils.

4.1.2 Safety during installation/servicing

As R410A's pressure is about 1.6 times higher than that of R22, improper installation/servicing may cause a serious trouble. By using tools and materials exclusive for R410A, it is necessary to carry out installation/servicing safely while taking the following precautions into consideration.

- 1) Never use refrigerant other than R410A in an air conditioner which is designed to operate with R410A.
- 2) If a refrigeration gas leakage occurs during installation/servicing, be sure to ventilate fully.
If the refrigerant gas comes into contact with fire, a poisonous gas may occur.
- 3) When installing or removing an air conditioner, do not allow air or moisture to remain in the refrigeration cycle. Otherwise, pressure in the refrigeration cycle may become abnormally high so that a rupture or personal injury may be caused.
- 4) After completion of installation work, check to make sure that there is no refrigeration gas leakage.
If the refrigerant gas leaks into the room, coming into contact with fire in the fan driven heater, space heater, etc., a poisonous gas may occur.
- 5) When an air conditioning system charged with a large volume of refrigerant (e.g. multi type air conditioner) is installed in a small room, it is necessary to exercise care so that, even when refrigerant leaks, its concentration does not exceed the marginal level.
If the refrigerant gas leakage occurs and its concentration exceeds the marginal level, an oxygen starvation accident may result.
- 6) Be sure to carry out installation or removal according to the installation manual.
Improper installation may cause refrigeration trouble, water leakage, electric shock, fire, etc.
- 7) Unauthorized modifications to the air conditioner may be dangerous. If a breakdown occurs please call a qualified air conditioner technician or electrician.
Improper repair's may result in water leakage, electric shock and fire, etc.

4.2 Refrigerant piping installation

4.2.1 Piping materials and joints used

For the refrigerant piping installation, copper pipes and joints are mainly used. Copper pipes and joints suitable for the refrigerant must be chosen and installed. Furthermore, it is necessary to use clean copper pipes and joints whose interior surfaces are less affected by contaminants.

(1) Copper pipes

It is necessary to use seamless copper pipes which are made of either copper or copper alloy and it is desirable that the amount of residual oil is less than 40 mg/10m. Do not use copper pipes having a collapsed, deformed or discolored portion (especially on the interior surface). Otherwise, the expansion valve or capillary tube may become blocked with contaminants.

As an air conditioner using R410A incurs pressure higher than when using R22, it is necessary to choose adequate materials. Thicknesses of copper pipes used with R410A are as shown in Table 3. Never use copper pipes thinner than 0.8 mm even when it is available on the market.

Table 3. Thicknesses of annealed copper pipes

Nominal diameter	Outer diameter (mm)	Thickness (mm)	
		R410A	[ref.]R22
1/4	6.35	0.80	0.80
3/8	9.52	0.80	0.80
1/2	12.7	0.80	0.80

(2) Joints

For copper pipes, flare joints or socket joints are used. Prior to use, be sure to remove all contaminants.

a) Flare joints

Flare joints used to connect the copper pipes cannot be used for pipings whose outer diameter exceeds 20 mm. In such a case, socket joints can be used.

Все каталоги и инструкции здесь: <http://splitoff.ru/tehn-doc.html>

Also, union, half

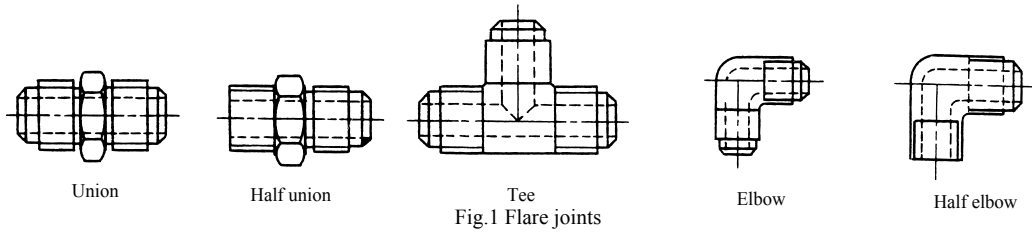

b) Socket joints

Socket joints are such that they are brazed for connections, and used mainly for thick pipings whose diameter is larger than 20 mm. Thicknesses of socket joints are as shown in Table 4. Socket, elbow-type and tee-type shapes are generally used (see Fig. 2).

Table 4. Minimum thicknesses of socket joints

Nominal diameter	Reference outer diameter of copper pipe jointed (mm)	Minimum joint thickness (mm)
1/4	6.35	0.50
3/8	9.52	0.60
1/2	12.7	0.70

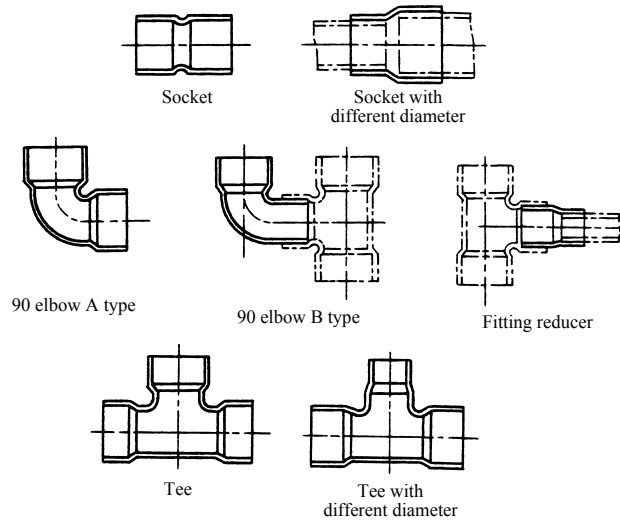

4.2.2 Processing of piping materials

When performing the refrigerant piping installation, care should be taken to ensure that water or dust does not enter the pipe interior, that no other oil other than lubricating oils used in the installed air conditioner is used, and that refrigerant does not leak. When using lubricating oils in the piping processing, use such lubricating oils whose water content has been removed. When stored, be sure to seal the container with an airtight cap or any other cover.

(1) Flare processing procedures and precautions

a) Cutting the pipe

By means of a pipe cutter, slowly cut the pipe so that it is not deformed.

b) Removing burrs and chips

If the flared section has chips or burrs, refrigerant leakage may occur. Carefully remove all burrs and clean the cut surface before installation.

c) Insertion of flare nut

d) Flare processing

Make certain that a clamp bar and copper pipe have been cleaned.

By means of the clamp bar, perform the flare processing correctly.

Use either a flare tool for R410A or conventional flare tool

Все каталоги и инструкции здесь: <http://splitoff.ru/tehn-doc.html>

When using a conventional flare tool, be sure to secure “dimension A” by using a gage for size adjustment.

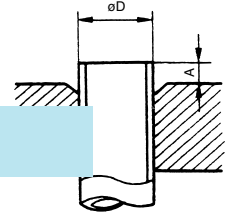

Fig.3 Flare processing dimensions

Table 5. Dimensions related to flare processing for R410A

Nominal diameter	Outer diameter (mm)	Thickness (mm)	A (mm)		
			Flare tool for R410A Clutch type	Conventional flare tool	
				Clutch type	Wing nut type
1/4	6.35	0.8	0~0.5	1.0~1.5	1.5~2.0
3/8	9.52	0.8	0~0.5	1.0~1.5	1.5~2.0
1/2	12.7	0.8	0~0.5	1.0~1.5	2.0~2.5

Table 6. Dimensions related to flare processing for R22

Nominal diameter	Outer diameter (mm)	Thickness (mm)	A (mm)		
			Flare tool for R410A Clutch type	Conventional flare tool	
				Clutch type	Wing nut type
1/4	6.35	0.8	0~0.5	0.5~1.0	1.0~1.5
3/8	9.52	0.8	0~0.5	0.5~1.0	1.0~1.5
1/2	12.7	0.8	0~0.5	0.5~1.0	1.5~2.0

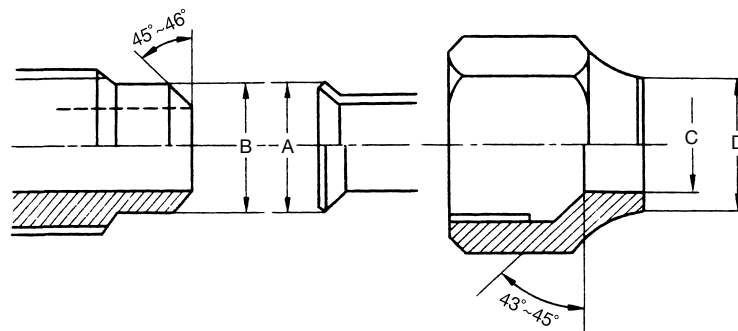

Fig.4 Relations between flare nut and flare seal surface

Table 7. Flare and flare nut dimensions for R410A

[unit: mm]

Nominal diameter	Outer diameter (mm)	Thickness (mm)	Dimension (mm)				Flare nut width
			A	B	C	D	
1/4	6.35	0.8	9.1	9.2	6.5	13	17
3/8	9.52	0.8	13.2	13.5	9.7	20	22
1/2	12.7	0.8	16.6	16.0	12.9	23	26

Table 8. Flare and flare nut dimensions for R22

[unit: mm]

Nominal diameter	Outer diameter (mm)	Thickness (mm)	Dimension (mm)				Flare nut width
			A	B	C	D	
1/4	6.35	0.8	9.0	9.2	6.5	13	17
							22
1/2	12.7	0.8	16.2	16.0	12.9	20	24

Все каталоги и инструкции здесь: <http://splitoff.ru/tehn-doc.html>

(2) Flare connecting procedures and precautions

- a) Make sure that the flare and union portions do not have any scar or dust, etc.
- b) Correctly align the processed flare surface with the union axis.
- c) Tighten the flare with designated torque by means of a torque wrench. The tightening torque for R410A is same as that for conventional R22. Incidentally, when the torque is weak, the gas leakage may occur. When it is strong, the flare nut may crack and may be made nonremovable. When choosing the tightening torque, comply with values designated by manufacturers. Table 9 shows reference values.

Note : When applying oil to the flare surface, be sure to use oil designated by the manufacturer. If any other oil is used, the lubricating oils may deteriorate and cause the compressor to burn out.

Table 9. Tightening torque of flare for R410A [Reference values]

Nominal diameter	Outer diameter (mm)	Tightening torque N·m (kgf·cm)	Tightening torque of torque wrenches available on the market N·m (kgf·cm)
1/4	6.35	14~18 (140~180)	16 (160), 18 (180)
3/8	9.52	34~42 (340~420)	42 (420)
1/2	12.7	49~61 (490~610)	55 (550)

4.2.3 Storage of piping materials

(1) Types and storage of piping materials

Refrigerant piping materials for air conditioners are broadly classified into the following types.

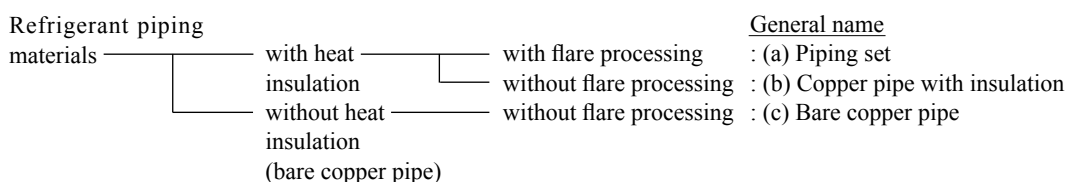

As R410A features pressure about 1.6 times higher than R22, it is necessary to use a copper pipe which has a thickness stated in Table 3 (see page 92) and which contains less contaminants. It is necessary to carefully treat/store copper pipes so that they are not collapsed, deformed or damaged. Due care must also be exercised so that foreign matters such as dust and water do not enter the pipe interior.

A piping set's open end is sealed with a cap, etc. When storing it, make sure that it is sealed securely. When storing a clad copper pipe or bare copper pipe, securely seal the opening with pinching, taping, etc.

(2) Identification

a) Piping set

A copper pipe as piping set for R410A must have a thickness as stated in Table 3 (see page 92), and, as shown in Tables 5 and 6 (see page 94), it also differs from R22 in flare processing and flare nut dimensions. So, it is necessary to choose a pip-

Все каталоги и инструкции здесь: <http://splitoff.ru/tehn-doc.html>

b) Copper pipe with insulation

Before using a copper pipe with insulation, make sure that it has a thickness designated for R410A.

c) Bare copper pipe

It is necessary to use a bare copper pipe which has a thickness designated in Table 3 (see page 92) and contains less contaminants. As the bare copper pipe surface is naked, it is necessary to treat it with exceeding care and adopt a means for identification to prevent improper usage by making it easily discriminable from other piping materials.

(3) Precautions before installation

Observe the following precautions when performing the piping connection at the site.

a) Keep any open ends of pipes be sealed with a cap, etc. until connected with the equipment.

b) Exercise great care when performing piping installation on a rainy day.

When water enters into the piping, the lubricating oil may deteriorate and cause the equipment to fail.

c) Carry out the piping connection in as short a time as possible.

If the piping is left open for a long period, fully purge the interior with nitrogen gas or dry it with a vacuum pump.

4.2.4 Brazing

(1) Processing the connected parts

As brazing is molten between the joined surfaces to yield high adhesive strength, it is necessary to secure a wide enough space to be joined and also an adequate clearance between the joined surfaces. Copper pipe joints' minimum insertion depths, outer pipe diameters and clearances between outer and inner pipe diameters are as shown in Table 10. In the case of bronze brazing filler, when the clearance is about 0.05~0.1mm, the pipes can be connected most strongly.

Table 10. Copper pipe joints' minimum insertion depths and clearances

Outer pipe diameter D (mm)	Minimum insertion depth B (mm)	Clearance (A-D) × 1/2 (mm)
5~8	6	0.05~0.35
8~12	7	0.05~0.35
12~16	8	0.05~0.45

* When joining the pipes, either the pipe ends are processed, or pipes are connected by brazing with a socket joint.

(2) Brazing filler metal

a) Alloy brazing filler

An alloy mainly composed of silver and copper is used to join iron, copper or copper alloy. Although it excels in solderability, it is relatively expensive.

b) Phosphor bronze brazing filler

Phosphor bronze brazing filler is generally used to join copper or copper alloy.

c) Low temperature solder

An alloy of tin and lead. An ordinary type of solder. Since it is weak in adhesive strength, it should not be used for refrigerant pipe brazing.

* Cautions:

- 1) BCuP tends to react with sulphur and produce a fragile compound water solution, which may cause a gas leakage. So, use any other type of brazing filler at a hot spring resort, etc., and coat the surface with a paint.
- 2) When performing brazing again at the time of servicing, use the same type of brazing filler.

(3) Flux

a) Reasons for the use of flux

- By removing the oxide film and any foreign matter on the metal surface, it assists the flow of brazing filler.
- In the brazing process, it prevents the metal surface from being oxidized.

Все каталоги и инструкции здесь: <http://splitoff.ru/tehn-doc.html>

b) Properties required for flux

- Temperature at which flux is active coincides with the brazing temperature.
- Due to a wide effective temperature range, flux is hard to carbonize.
- It is easy to remove slag after brazing.
- The corrosive action to the treated metal and brazing filler is negligible.
- Excels in coating performance and is harmless to the human body.

As the flux works in a complicated manner as described above, it is necessary to choose an adequate type of flux according to the type and shape of treated metal, type of brazing filler and brazing method, etc.

c) Types of flux

• Incorruptible flux

Generally, it is a compound of borax and boric acid.

Effective in cases where the brazing temperature is higher than 800°C.

• Activated flux

Most of fluxes generally used for silver brazing fall under this type.

It features an increased oxide film removing capability due to the addition of compounds such as potassium fluoride, potassium chloride and sodium fluoride, to the borax-boric acid compound.

* Cautions:

- ① Remove the flux after brazing.
- ② When chlorine contained in the flux stays within the pipe, the lubricating oil deteriorates. So, use a flux which does not contain chlorine.
- ③ When adding water to the flux, use water which does not contain chlorine (e.g. distilled water or ion-exchange water).

(4) Brazing

As brazing requires sophisticated techniques and experiences, it must be performed by a qualified person.

In order to prevent the oxide film from occurring in the pipe interior during brazing, it is effective to proceed with brazing while letting dry nitrogen gas (N₂) flow.

<Brazing method for preventing oxidation>

- a) Attach a reducing valve to the nitrogen gas cylinder
- b) Use a copper pipe to direct the nitrogen gas into the piping, and attach a flowmeter to the nitrogen gas cylinder.
- c) Apply a seal onto the clearance between the piping and inserted pipe for the nitrogen gas in order to prevent the nitrogen gas from flowing backward.
- d) When the nitrogen gas is flowing, be sure to keep the piping end open.
- e) Adjust the flow rate of nitrogen gas so that it is lower than 0.05m³/h, or 0.02MPa (0.2kgf/cm²) by means of the reducing valve.
- f) After taking the steps above, keep the nitrogen gas flowing until the piping cools down to a certain extent (i.e. temperature at which pipes are touchable with finger).
- g) Completely remove the flux after brazing.

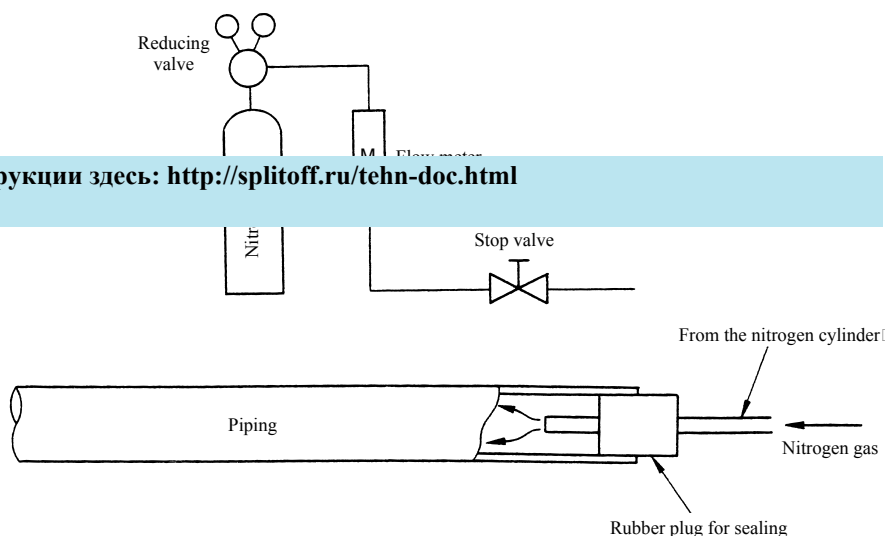

Fig.5 Prevention of oxidation during brazing

* Cautions during brazing

① General cautions

- 1) The brazing strength should be high as required.
- 2) After operation, airtightness should be kept under a pressurized condition.
- 3) During brazing do not allow component materials to become damaged due to overheating.
- 4) The refrigerant pipe work should not be come blocked with scale or flux.
- 5) The brazed part should not restrict the flow in the refrigerant circuit.
- 6) No corrosion should occur from the brazed part.

② Prevention of overheating

Due to heating, the interior and exterior surfaces of treated metal may oxidize. Especially, when the interior of the refrigerant circuit oxidizes due to overheating, scale occurs and stays in the circuit as dust, thus exerting a fatally adverse effect. So, make brazing at adequate brazing temperature and with a minimum of heating area.

③ Overheating protection

In order to prevent components near the brazed part from overheating damage or quality deterioration due to flame or heat, take adequate steps for protection such as (1) by shielding with a metal plate, (2) by using a wet cloth, and (3) by means of heat absorbent.

④ Movement during brazing

Eliminate all vibration during brazing to protect brazed joints from cracking and breakage.

⑤ Oxidation preventive

In order to improve the brazing efficiency, various types of antioxidant are available on the market. However, the constituents of these are widely varied, and some are anticipated to corrode the piping materials, or adversely affect HFC refrigerant, lubricating oil, etc. Exercise care when using an oxidation preventive.

4.3 Installation, removal and servicing

4.3.1 Tools for R410A

In the case of an air conditioner using R410A, in order to prevent any other refrigerant from being charged accidentally, the service port diameter of the outdoor unit service valve (3-way valve) has been changed. Also, to increase the pressure resisting strength, flare processing dimensions and sizes of opposite sides of flare nuts (for copper pipes with nominal diameters 1/2 and 5/8) have been changed. During installation/service, therefore, prepare tools exclusive for R410A shown in (1) on page 99 and general tools shown in (2) on page 100.

(1) Tools exclusive for R410A

a) Gauge manifold

- As R410A is characterized by high pressure, conventional tools cannot be used.

Table 11. Differences between conventional high/low pressure gauges and those for R410A

Все каталоги и инструкции здесь: <http://splitoff.ru/tehn-doc.html>

High pressure gauge (red)	-0.1~3.5MPa -76 cmHg~35 kgf/cm ²	-0.1~3.5MPa -76 cmHg~53 kgf/cm ²
Compound gauge (blue)	-0.1~1.7MPa -76 cmHg~17 kgf/cm ²	-0.1~3.8MPa -76 cmHg~38 kgf/cm ²

- In order to prevent any other refrigerant from being charged accidentally, each port of the manifold has been changed in shape.

Table 12. Differences in port size between conventional manifold and that for R410A

	Conventional manifold	Manifold for R410A
Port size	7/16 UNF 20 threads per inch	1/2 UNF 20 threads per inch

b) Charge hose

- As R410A is characterized by high pressure, the pressure resistance of the charge hose has been increased. The material has also been changed to an HFC resistant type, and, as in the case of each port of the manifold, the hose cap size has been changed. Furthermore, for prevention of gas pressure reaction, a charge hose with a valve placed near the cap is also available.

Table 13. Differences between conventional charge hose and that for R410A

		Conventional charge hose	Charge hose for R410A
Pressure resistance	Normal pressure	3.4 MPa (34 kgf/cm ²)	5.1 MPa (51 kgf/cm ²)
	Breaking pressure	17.2 MPa (172 kgf/cm ²)	27.4 MPa (274 kgf/cm ²)
Engineering material		NBR rubber	HNBR rubber internally coated with nylon
Cap size		7/16 UNF 20 threads per inch	1/2 UNF 20 threads per inch

c) Electronic balance for refrigerant charging

- As R410A belonging to the HFCs features high pressure and high evaporating speed, when R410A is charged by using a charging cylinder, R410A in the cylinder cannot be kept in a liquefied state and gasified refrigerant bubbles in the charging cylinder, it becomes difficult to read values. Therefore, it is advisable to adequately use an electronic balance for refrigerant charging.
- An electronic balance for refrigerant charging has higher strength due to its structure with four points of support for refrigerant cylinder weight detection. As the charge hose connecting part has two ports-one for R22 (7/16 UNF 20 threads per inch) and the other for R410A (1/2 UNF 20 threads per inch) - it can also be used for charging the conventional refrigerant.
- Two types of electronic balance for refrigerant charging are available - one for 10kg cylinder and the other for 20kg cylinder.
 - Electronic balance for 10kg cylinder precision $\pm 2g$
 - Electronic balance for 20kg cylinder precision $\pm 5g$
- Refrigerant is charged manually by opening/closing the valve.

d) Torque wrench (for nominal diameters 1/2 and 5/8)

- Along with changes in flare nut sizes for enhanced pressure resisting strength, torque wrenches for R410A differ in opposite side size.

Table 14. Differences between conventional wrenches and those for R410A

	Conventional torque wrench	Torque wrench for R410A
For 1/2 (opposite side \times torque)	24mm \times 55N·m (550 kgf·cm)	26mm \times 55N·m (550 kgf·cm)
For 5/8 (opposite side \times torque)	27mm \times 65N·m (650 kgf·cm)	29mm \times 65N·m (650 kgf·cm)

e) Flare tool (clutch type)

- A flare tool for R410A is provided with a large clamp bar receiving hole so that the projection of the copper pipe from the clamp bar can be set at 0~0.5 mm in flare processing, and also features higher spring strength for increased expansion pipe torque. This flare tool can also be used for R22 copper pipe.

Все каталоги и инструкции здесь: <http://splitoff.ru/tehn-doc.html>

h type])

- A gauge 1.0 mm in thickness which helps in easily setting the projection of the copper pipe from the clamp bar at 1.0~1.5 mm.

g) Vacuum pump adapter

- It is necessary to use an adapter for preventing vacuum pump oil from flowing back to the charge hose. The charge hose connecting part has two ports - one for conventional refrigerant (7/16 UNF 20 threads per inch) and the other for R410A. If the vacuum pump oil (mineral) mixes with R410A, a sludge may occur and damage the equipment.

h) Refrigerant cylinder

- A refrigerant cylinder exclusive for R410A comes identified with refrigerant name and is coated with pink paint as designated by the ARI, U.S.A.

i) Charge port and packing for refrigerant cylinder

- According to the charge hose's cap size, a charge port with 1/2 UNF 20 threads per inch and corresponding packing are required.

j) Gas leakage detector

- A high sensitivity gas leakage detector exclusive for HFC refrigerant is used. In the case of R410A, the detection sensitivity is about 23g per year.

(2) General tools

a) Vacuum pump

g) Hole core drill (ø65 or 70)

b) Torque wrench

h) Hexagonal wrench (opposite side 4 or 5 mm)

- for 1/4: opposite side 17 mm × (16 N·m)
(160 kgf·cm)
- for 1/4: opposite side 17 mm × (18 N·m)
(180 kgf·cm)
- for 3/8: opposite side 22 mm × (42 N·m)
(420 kgf·cm)

i) Spanner, or monkey wrench

j) Tape measure

c) Pipe cutter

k) Thermometer

d) Reamer

l) Clamping ampere meter

e) Screwdriver (+, -)

m) Insulation resistance tester (mega tester)

f) Hacksaw

n) Electro circuit tester

o) Pipe bender

(3) Applicability of R410A tools to R22 model

Table 15. Applicability of R410A tools to R22 model

	Tools for R410A	Applicable to R22 model
a)	Gauge manifold	X
b)	Charge hose	X
c)	Electronic balance for refrigerant charging	○
d)	Torque wrench (nominal diameter 1/2, 5/8)	X
e)	Flare tool (clutch type)	○
f)	Gauge for projection adjustment*	○
g)	Vacuum pump adapter	○
h)	Refrigerant cylinder	X
i)	Charge port and packing for refrigerant cylinder	X
j)	Gas leakage detector	X

* Used when conventional flare tool (clutch type) is used.

Note: For inquiry, contact your agent.

4.3.2 New installation work (when using new refrigerant piping)

- (1) Air purge by vacuum pump and gas leakage inspection (see Fig. 6)
 - a) Connect the charge hose to the outdoor unit. ①
 - b) Connect the charge hose to the vacuum pump adapter. ②

At this time, keep the service valves in the fully closed position. ③ ④

Все каталоги и инструкции здесь: <http://splitoff.ru/tehn-doc.html>

t manufacturer's

manual.

- d) When the compound gauge's pointer has indicated -101 kPa (-755 mmHg) ⑥, place the handle Lo in the fully closed position ⑤, and turn OFF the vacuum pump's power switch
Keep this state for 1~2 minutes, and ascertain that the compound gauge's pointer does not return.
- e) Fully open the service valves. ③ ④
- f) Detach the charge hoses. ① ②
- g) Tightly secure the cap on the service port. ⑦
- h) After securing the caps on the service valves, check the caps' periphery if there is any gas leakage. ③ ④ ⑦

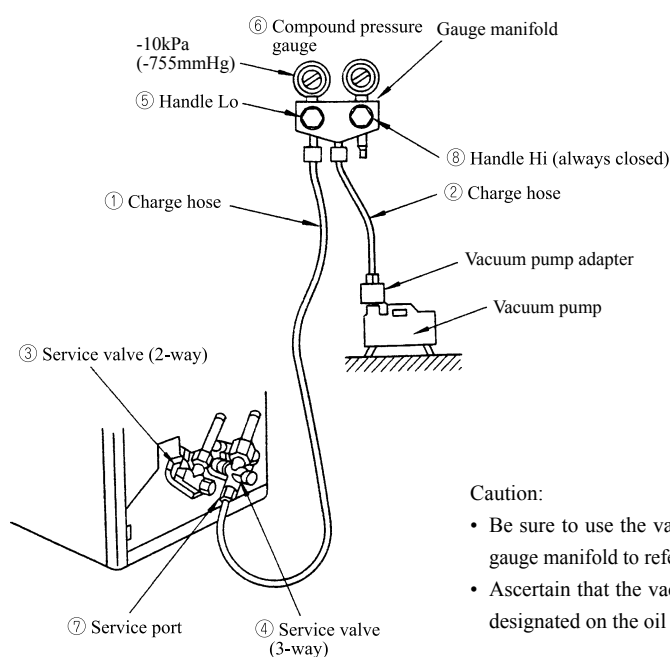

Caution:

- Be sure to use the vacuum pump, vacuum pump adapter and gauge manifold to refer to their instruction manuals beforehand.
- Ascertain that the vacuum pump is filled with oil to the level designated on the oil gauge.

Fig.6 Configuration of air purge by vacuum pump

- (2) Additional refrigerant charging required for refrigerant piping length longer than standard length (The following steps should be taken following the step e) in (1) above. See Fig. 7)
 - a) Set the refrigerant cylinder to the electronic balance, and connect the connecting hoses on the cylinder and electronic balance's connecting port.
 - * Caution:
Be sure to make setting so that liquid can be charged. When using a cylinder equipped with a siphon, liquid can be charged without turning it upside down.
 - b) Connect the gauge manifold's charge hose to the electronic balance's connecting port. ③ ②
 - c) Open the refrigerant cylinder's valve, and, after opening the charging valve a little, close it. ① ②
 - d) After making zero (0) adjustment, open the charging valve and, by opening the gauge manifold's valve Lo, charge the liquid refrigerant. ② ⑤
(Before handling the electronic balance, refer to its instruction manual).
 - e) When the designated amount of refrigerant could not be charged, make additional charging bit by bit by cooling operation (for the amount of each addition, follow the instruction manual prepared by the equipment manufacturer). If the first additional charging was not enough, make the second additional charging after about one minute in the same manner as the first additional charging.
 - * Caution:
Be sure never to charge a large amount of liquid refrigerant at once to the unit in cooling mode, since liquid is charged from the gas side.

- f) After charging liquid refrigerant into the air conditioner by closing the charging valve, stop operation by fully closing the gauge manifold's valve Lo. ② ⑤
- g) Quickly remove the charge hose from the service port. ⑥
When stopped halfway, refrigerant being cycled will be released.

Все каталоги и инструкции здесь: <http://splitoff.ru/tehn-doc.html>

is leakage. ⑥ ⑦

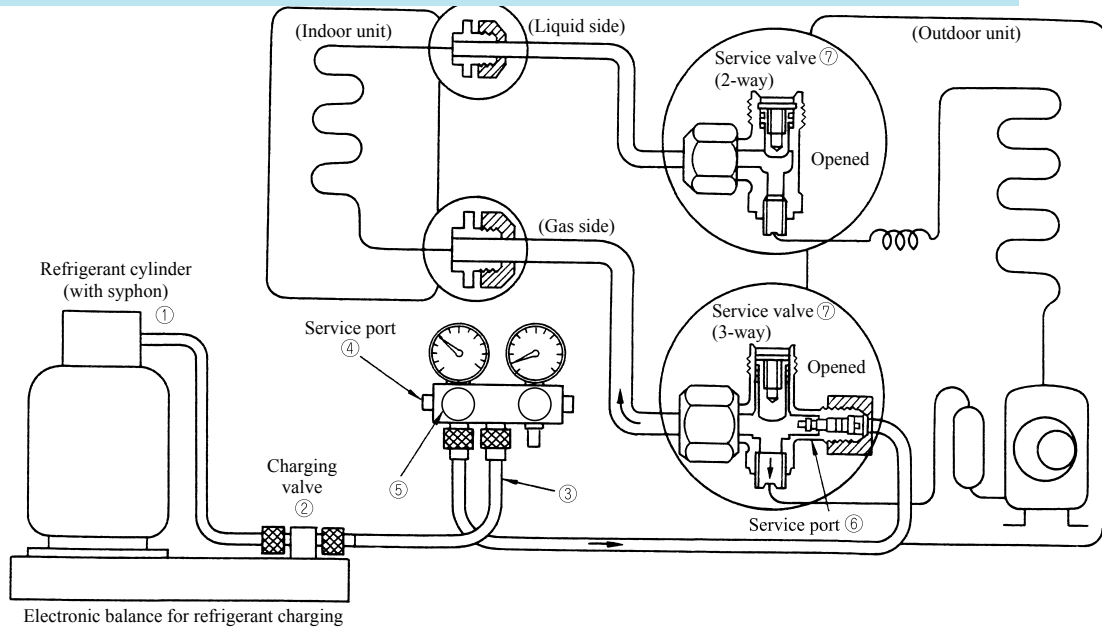

Fig.7 Configuration of additional refrigerant charging

4.3.3 Removal (When using new refrigerant piping)

- (1) Removing the unit
 - a) Recovery of refrigerant from the outdoor unit by pump down
 - At the time of pump down, use a gauge manifold exclusive for R410A.
 - Operating the unit in forced cooling mode, recover refrigerant from the outdoor unit.
(For details of reclaiming steps and precautions, see the instruction manual prepared by the equipment manufacturer)

* Caution:
In the case of an outdoor unit which is incapable of pump down, use a refrigerant recovery unit.
 - b) Removing the indoor/outdoor units
 - Remove the piping and wiring between the indoor and outdoor units.
 - Tighten the outdoor unit's service valves and service port with the specified torque.
 - Tighten the capped flare nuts at the indoor/outdoor units connecting part with the specified torque.
 - Remove the indoor/outdoor units.

* Caution:
When storing the indoor unit piping in its original position, be careful not to break the piping.
- (2) Installing the unit
 - a) Proceed with the installation following the steps described in "4.3.2 New installation work".

4.3.4 Replacing the unit (Never use the existing refrigerant piping)

Use a brand-new refrigerant piping (1) when replacing the air conditioner using the conventional refrigerant (R22) with an air conditioner using the alternative refrigerant (R410A) or (2) even when replacing the air conditioner using the alternative refrigerant (R410A) with another air conditioner using R410A, as a problem may occur due to differences in pressure characteristics of refrigerant or differences in type of lubricating oil (air conditioners using R410A do not always use the same type of the lubricating oils).

4.3.5 Retrofitting

Do not operate the air conditioner which has used the conventional refrigerant (R22) by charging the alternative refrigerant (R410A). Otherwise, the equipment may cease to function normally and go wrong, or even cause serious problems such as rupture of the refrigeration cycle.

4.3.6 Refrigerant recharging at servicing

When it becomes necessary to recharge refrigerant, charge the specified amount of new refrigerant according to the following steps.

(For details, see the instruction manual prepared by the equipment manufacturer)

Все каталоги и инструкции здесь: <http://splitoff.ru/tehn-doc.html>

ed position.

- 3) Place the handle *Lo* in the fully opened position, and turn ON the vacuum pump's power source. (For the evacuating time, refer to the equipment manufacturer's manual)
- 4) When the compound gauge's pointer has indicated -101 kPa (-755 mmHg), place the handle *Lo* in the fully closed position, and turn OFF the vacuum pump's power source. Keep this state for 1 ~ 2 minutes, and ascertain that the compound gauge's pointer does not return.
- 5) Charge liquid refrigerant by using the electronic balance according to the steps described in Section 4.3.2 (2) (See pages 101, 102).

4.4 Refrigerant recovery

4.4.1 Recovering procedures

The following procedures for refrigerant recovery represent general procedures, and they may differ between actual cases depending upon the type of refrigerant recovering equipment. The connecting and handling methods for different type of refrigerant recovering equipment may also differ. So, ascertain the details by referring to the respective instruction manuals, etc.

- (1) Checks prior to recovering procedures
 - a) Checking the refrigerant recovering equipment
 - ① Gas leakage [If there is any malfunction, repair it].
 - ② Oil separator [Drain the residual oil].
 - ③ Recovering equipment weighing function, overcharge preventing function (float switch), moisture indicator, drier and other accessory functions [should be adjusted or replaced where necessary].
 - ④ Electrical circuit
 - b) Checking the accessories to the refrigerant recovering equipment
- (2) Preparations for recovering procedures
 - a) Installation of refrigerant recovering equipment

Install the equipment in a place which satisfies the following requirements as much as possible.

 - ① Ambient temperature is higher than 0°C and lower than 40°C.
 - ② A flat and dry floor.
 - ③ A place as close to the air conditioner as possible.
 - b) Preparation of recovering cylinder

A recovering cylinder should be such that it does not go against prohibitions, and is suitable for refrigerant recovered.
 - c) Connect to the power source
 - d) Preparations for air conditioner subjected to refrigerant recovery
 - ① When it is possible to run the air conditioner subjected to refrigerant recovery, perform pump down operation so that refrigerant is contained in the outdoor unit (condenser side).
 - Carry out the pump down operation after confirming the specification of the air conditioner subjected to refrigerant recovery.
 - ② If there is any clogging part (ex. the electronic expansion valve, etc.), fully open such part.

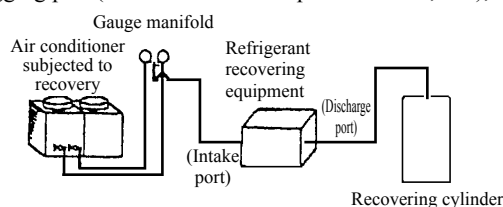

- (3) Connection of refrigerant recovering equipment
 - a) Connect the air conditioner subjected to refrigerant recovery to the refrigerant recovering equipment.
 - ① When there is a service port (port for recovery):

Make connection to the service port (port for recovery) by using a gauge manifold and charge hose.
 - ② When there is no service port (port for recovery):

Make connection in a manner similar to ① above by using a piercing valve.
 - b) Connect the refrigerant recovering equipment to the recovering cylinder.

- (4) Recovering procedures
- According to the instructions for handling the refrigerant recovering equipment (described in the attached instruction manual), operate the equipment to recover refrigerant.
 - During the operation, take care of the following cautions.

Все каталоги и инструкции здесь: <http://splitoff.ru/tehn-doc.html>

operation so that

- During the operation, remain at work site to ensure safety.
 - If you have to leave your work site for any unavoidable reason, stop the operation after ascertaining that the recovering cylinder is not overcharged.
 - During the operation, if the refrigerant recovering equipment's overcharging prevention mechanism operates and the equipment stops automatically, replace the recovering cylinder with an empty one.
 - If the pressure gauge's reading increases after a short time from the accomplishment of recovery and automatic stoppage of the refrigerant recovering equipment, restart the equipment and, if it stops again, finish the recovery.
- (5) Procedures after recovery
- Close the valves on the air conditioner subjected to refrigerant recovery, the refrigerant recovering equipment and the recovering cylinder.
 - Detach the recovering cylinder charged with refrigerant and store it as required by law.

4.4.2 Accessories/tools

In order to carry out R410A recovery, a variety of accessories/tools are required.

Shown below are standard accessories.

(1) Recovering cylinder

- Use a recovering cylinder designated by the equipment manufacturer.
- A detachable cylinder must be such that it complies with the laws and regulations concerned.
- Do not use an ordinary cylinder as a recovering cylinder.

Note 1: A cylinder available when R410A was purchased, is a borrowed one.

Note 2: As a cylinder available when R410A was purchased, is provided with a check valve, it cannot be used as a recovering cylinder.

- Types (by function)

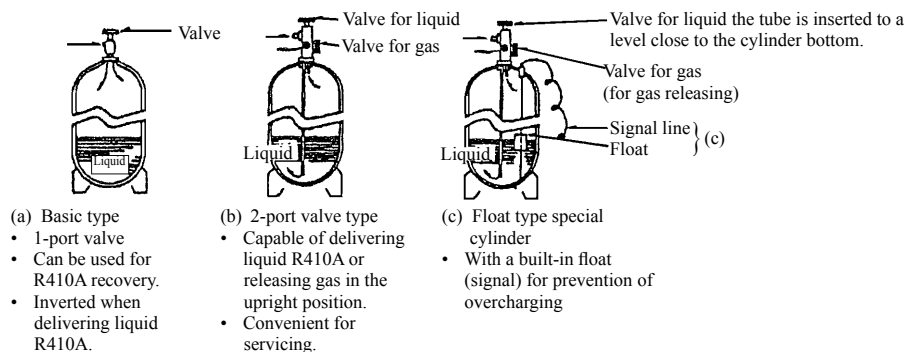

Fig.8 Cylinder types

- Caution

It is prohibited by law to recover R410A into a throw-away service can or one-way cylinder.

(2) Drier

- A desiccant container for removing the water content of R410A.
- A drier should be prepared as expendables.
- Keep the drier sealed just before fitting it.
- Required to protect the R410A recovering equipment.

(3) Connection hose

a) Charge port and charge port packing

- Usually, it is sold independently of a refrigerant cylinder.
- In the case of a two-port cylinder, the diameter may be special. Inquire the manufacture for confirmation.
- A packing is expendables.

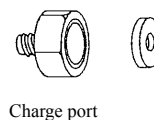

- b) Charge hose (pressure resistant hose for fluorocarbon) and packing
 - It is 1/4B in thickness and available in various lengths, etc.
 - Use a hose whose pressure resisting performance is higher than 5.2 MPa (52 kg/cm²G).
 - Generally, a setting fixture is provided only on one end.

Все каталоги и инструкции здесь: <http://splitoff.ru/tehn-doc.html>

- The most important service tool for refrigeration and air conditioner.
- Widely used when charging/recovering R410A while checking gas pressure.

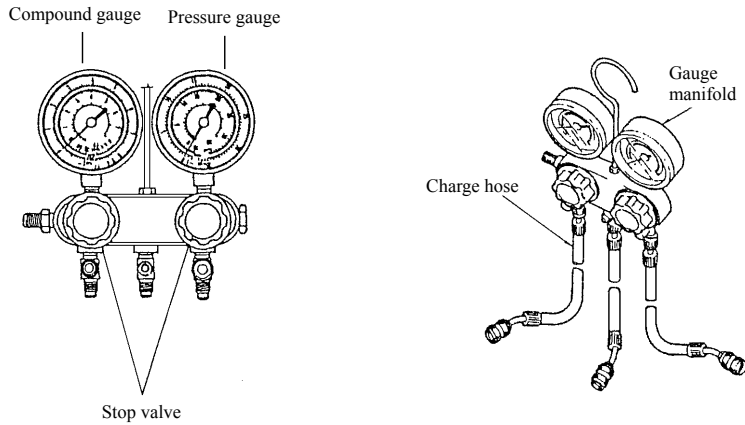
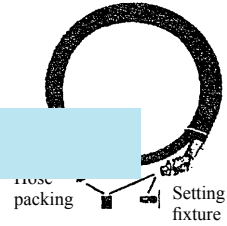

(5) Tube piercing valve

- a) A tool used to make a hole for recovery in the copper pipe when recovering R410A from equipment which has no port for charging or recovering gas. Various types are available on the market and given various names.
- b) As the piercing edge tends to wear, it is necessary to treat this valve as semi-expendables.
- c) As vacuum rises, air tends to be inhaled from the hole. So, care must be exercised.

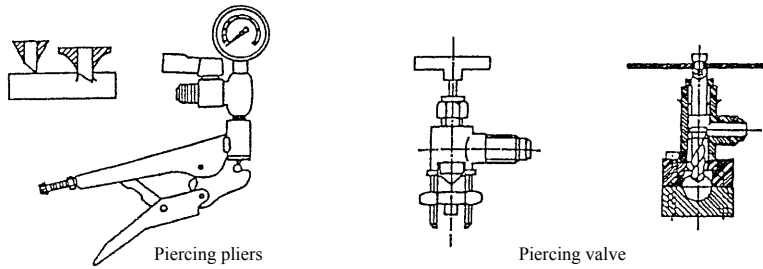

(6) Vacuum pump

Used to evacuate the recovering equipment and recovering cylinder.

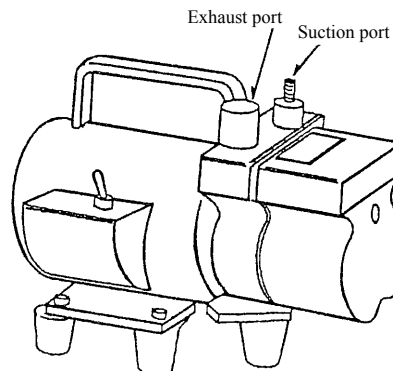

INVERTER WALL MOUNTED TYPE AND FLOOR STANDING TYPE ROOM AIR-CONDITIONER



Air-Conditioning & Refrigeration Systems Headquarters
16-5, 2-chome, Kounan, Minato-ku, Tokyo, 108-8215, Japan
Fax : (03) 6716-5926

Because of our policy of continuous improvement. we reserve the right to make changes in all specifications without notice.

updated 24, April, 2009



**Большая библиотека технической документации
<http://splitoff.ru/tehn-doc.html>
каталоги, инструкции, сервисные мануалы, схемы.**